

RADIO

JULY 1941

A McGRAW-HILL Publication Price 25c

*and
Television*

RETAILING



Keep Your **EYE** On **PROFITS**

It's Here!

The New
P. R. MALLORY & CO. Inc.
MALLORY
Replacement
VOLUME CONTROL



THE PERFECT SIZE
FOR EVERY
APPLICATION!



PRECISION-BUILT
LIKE A
FINE WATCH!



MORE RUGGEDNESS
THAN YOU'VE
EVER SEEN BEFORE!



AN A-C SWITCH
THAT SNAPS ON AND
STAYS ON!

Completely New... And All-Mallory

A Masterpiece of Fine Engineering!



**SEE IT...
TRY IT...
TODAY!**

Save your old Aluminum parts. It is patriotic to give them to National Defense.



Coming Next Month!
The New **MYE** (1th Edition)

Bigger and Better
Than Ever!

Order Now!

Get In Touch With Your
Distributor Today!

Mallory
Replacement Condensers
... More Popular Than Ever!



More and more service engineers are recognizing the value of Mallory's long-life construction... the mounting features which others have tried to copy... and, in the case of paper tubular condensers, Mallory's color-coding for instant voltage-identification. Here are the *only* replacement condensers you need. They save you time—save you money—do a job you can back up!

P. R. MALLORY & CO., Inc., INDIANAPOLIS, INDIANA • Cable Address—PELMALLO

More
than ever
—INSIST ON

P. R. MALLORY & CO. Inc.
MALLORY
APPROVED
PRECISION PRODUCTS

VIBRATORS • VIBRAPACKS • CONDENSERS •
VOLUME CONTROLS • ROTARY SWITCHES •
SINGLE AND MULTIPLE PUSH BUTTON SWITCHES
• RESISTORS • RADIO HARDWARE

RADIO *and Television* RETAILING

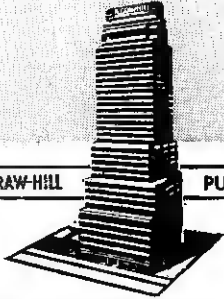

A McGRAW-HILL

PUBLICATION

JULY 1941

W. MacDONALD Editor
 W. CARL DORF Associate Editor
 VIN ZELUFF Technical Editor
 A. XIQUES Assistant Editor
 HARRY PHILLIPS Art Director

R. E. McGRAW Manager
 J. A. SAMBORN Eastern Manager
 K. R. GROENER Western Manager

KEEP YOUR EYE ON PROFITS	11
SALES PHOTOSHORTS	12
MORE NEW MODELS	14
RECORDS BY PHONE	18
QUALITY SALES TAKE TECHNIQUE	19
NEWS ABOUT TWO BABIES	20
HOW TO MAKE INSPECTION CHARGES STICK	21
WILL THERE BE A SERVICEMAN SHORTAGE	22
IDEAS UNDER GLASS	24
DO YOU FINANCE YOUR OWN PAPER	25
SOUND FOR 125,000	28
BATTERIES FOR PORTABLES	30
PREVIEW OF NEW PRODUCTS	31
INSIDE STUFF	34
ON THE NEWSFRONT	35
BENCHES BEFORE AND AFTER	42
CIRCUITS OF THE MONTH	43
SERVICING HIGH FIDELITY RECEIVERS	48
TRICKS OF THE TRADE	50



SALES STATIC . . . There was so much storage space in the bottom that I hated to see it go to waste

McGRAW-HILL PUBLISHING CO., INC.

RADIO and Television RETAILING, July, 1941, Vol. 26, No. 7. Published monthly, price 20c copy. Allow at least ten days for change of address. All communications about subscriptions should be addressed to the Director of Circulation, 330 West 42nd Street, New York, N. Y.

Subscription rates—United States and possessions, Mexico and Central American countries \$1.00 for two years. Canada \$1.50 for two years. Great Britain and British Possessions 9 shillings for two years. All other countries \$1.50 for two years. Printed in U. S. A. Entered as Second Class Matter, April 29, 1939, at Post Office, Albany, N. Y., under the Act of March 3, 1879. Cable address "Mcgrawhill, New York." Member of A.P.B. Member of A.B.C. Copyright 1941 by McGraw-Hill Publishing Co., Inc., 330 West 42nd Street, New York, N. Y.

Branch Offices: 520 North Michigan Ave., Chicago; 68 Post St., San Francisco; Aldwych House, Aldwych, London, W.C.2; Washington; Philadelphia; Cleveland; Detroit; St. Louis; Boston; Atlanta, Ga.

JAMES H. MCGRAW
 Founder and Honorary Chairman

JAMES H. MCGRAW, JR., President
 Howard Ehrlich, Executive Vice President

Publication Office
 99-120 North Broadway, Albany, N. Y.

Mason Britton, Vice Chairman
 B. R. Putnam, Treasurer

Editorial and Executive Offices
 330 West 42nd Street, New York, N. Y.

D. C. McGraw, Secretary
 J. E. Blackburn, Jr., Director of Circulation

SEE IT! HEAR IT!

STROMBERG-CARLSON FOR 1942

Dramatic Advertising

FM Leadership

Hate and ugliness were a million miles away

we was weary... completely, utterly weary of a world filled with strife and sorrow and despair. Then he pressed a button and the world faded. A great symphony reached out and took him away from the things that hurt...

THAT IS MAGIC... the magic of fine music when it comes to you in all its purity and richness. That is music as Stromberg-Carlson now brings it to you... for the first time in radio.

Now, in your own home, you can enjoy virtually all the subtleties of tone and color you hear in the concert hall. For Stromberg-Carlson transmits the harmonies and overtones, the high notes and low notes that radio has previously been unable to capture. If you want a new experience in musical enjoyment... if you want the satisfaction of music as it was meant to be heard... listen to the radio Stromberg-Carlson gives you today.

WHY DOES ONLY THIS RADIO GIVE YOU THE FULL BENEFIT OF FREQUENCY MODULATION? Because a Stromberg-Carlson has a frequency range wide enough to reproduce the full range of an FM broadcast exactly as it is played in the studio or concert hall. Because only Stromberg-Carlson has the Acoustical Labyrinth that truly "re-creates" tone... and the Frequency Stabilizer that prevents any distortion in any audio volume. Because only Stromberg-Carlson, pioneer in wide transmission and reception for 47 years, has the amplified push-button control for FM. Hear the top ten records "Acoustical Labyrinth" (Ch), a radio-phonograph combination, and you will know why "There is nothing else out there a Stromberg-Carlson!"

STROMBERG-CARLSON
THE ONLY RADIO FOR FM AT THE MOMENT

THE FIRST RADIO FOR STANDARD TONEBARS

Dramatic Advertising: Gripping, human interest advertisements . . . the most powerful radio campaign in a decade! . . . will work for you in a series of full pages right through the peak selling months:

LIFE: The famous picture magazine that swings the buying judgments of 20,000,000 readers every week.

TIME: The vital weekly newsmagazine that 2,000,000 progressive people read from cover to cover.

THE NEW YORKER: Read each week by more than a million folks who want the best and newest aids to modern living.

In addition: Large newspaper space in key trading areas throughout the country will create interest among your best prospects . . . and a complete and new assortment of dynamic displays, posters, counter cards and folders will speed your selling job.

See for yourself the impact of this great new campaign. These few typical figures show its thorough coverage:

City	No. of Families	Magazine Readers of Stromberg-Carlson Advertisements
Boston, Mass.	179,200	372,124
Buffalo, N. Y.	139,860	110,423
Chicago, Ill.	842,578	566,428
Columbus, O.	75,621	77,275
Dallas, Tex.	67,119	81,158
Denver, Colo.	79,351	86,713
Kansas City, Mo.	108,641	73,634
New York, N. Y.	1,722,954	1,568,792
Pittsburgh, Pa.	155,079	195,701
San Francisco, Calif.	178,625	276,276
Seattle, Wash.	100,996	136,565
Washington, D. C.	125,554	241,582



No. 935-PL* (above) Igor Stravinsky Autograph Model Radio-Phonograph. FM, AM, short wave reception . . . push button tuning . . . Acoustical Labyrinth . . . tone-true Speaker . . . automatic record changer . . . permanent point. Height, 36"; width, 37 1/4"; depth, 17 1/2."

SELL IT!

...THE LINE THAT HAS EVERYTHING!

Quality Product

Profit Protection

TAKE A LOOK at what Stromberg-Carlson offers you for a great and profitable 1941-42:

FM Leadership: A two-year jump on competition in field-tested, proved performance on FM! Using the discoveries of Major Armstrong—who invented FM—Stromberg-Carlson today has its FM-AM sets in more homes than all other makes combined!

A Quality Product: Every Stromberg-Carlson set you sell is backed by 47 years of pioneer work in sound transmission and reception.

Profit Protection: In all 26 new models, with radios and combinations blanketing every important price bracket from \$24.95 to \$695,† Stromberg-Carlson gives you *protected* franchise selling . . . helps to banish "radio-shopping" and hold a more stable price structure.

For profitable business in 1942, "There is nothing finer than a Stromberg-Carlson!"

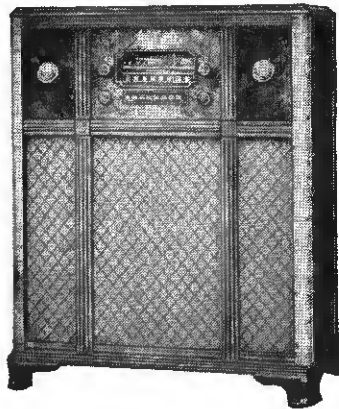

No. 920-L (above) Console Radio. AM and short wave reception . . . push button tuning . . . 5-position fidelity control . . . full-floating 12" dynamic speaker. Height, 38 3/8"; Width, 31 1/4"; Depth, 12 3/8".



No. 925-PF* (above) Radio-Phonograph. FM, AM, short wave reception . . . push button tuning . . . 12" speaker . . . automatic record changer . . . permanent point pick-up. Height, 36"; Width, 34 3/8"; Depth, 17 3/8".



No. 955-PF* (above) DeLuxe Radio-Phonograph. FM, AM, and short wave reception . . . push button tuning . . . Acoustical Labyrinth . . . 12" coaxial speaker system . . . automatic record changer. Height, 41 3/4"; Width, 47 1/2"; Depth, 18".

*Licensed under Armstrong FM Patents

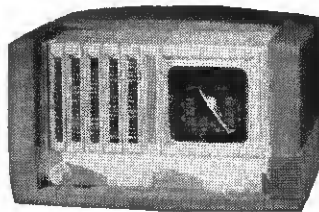

No. 900-H (above) Table Radio. AC-DC; AM reception . . . lighted dial . . . tone control . . . 5 1/4" speaker . . . modern, two-tone plastic cabinet. Height, 8 3/8"; Width, 13 3/4"; Depth, 8 1/2".

No. 920-PG (below) Radio-Phonograph. AM and short wave reception . . . push button tuning . . . 5-position fidelity control . . . 12" speaker . . . automatic record changer . . . crystal pick-up. Height, 34"; Width, 33 1/2"; Depth, 17 3/8".



†Prices quoted are F.O.B. Rochester, New York

STROMBERG-CARLSON

ROCHESTER, N. Y.

A FINER RADIO FOR STANDARD PROGRAMS . . . THE ONLY RADIO FOR FM AT ITS BEST

Farnsworth

CONTINUES TO PLAN FOR THE FUTURE



Although Farnsworth must contend with uncertainties like all other members of the radio industry, it is pushing ahead, confident that it can complete its aggressive merchandising program for the coming season.

The new Farnsworth line of radios and radio-phonographs is an excellent one, designed and engineered for fine performance and strong customer appeal. It is new in chassis and cabinet design—there are no carry-overs in the line. It is priced to return good margins of profit to our dealers.

The line covers every important price bracket. You already have seen our new portable receiv-

ers and battery-operated table models, which have proved so popular. On the opposite page you will find the new Farnsworth 5-tube and 6-tube AC-DC table models, on which production is scheduled for late in July. These will soon be followed by our consoles and radio-phonograph combinations, including a new Chairside automatic combination that we predict will be as popular as was Farnsworth's "73" of the past season, plus another Farnsworth innovation in a model that will instantly stand out as an exclusive design of widespread appeal.

This new line reflects Farnsworth traditions. As in previous years, it will offer the finest quality radio and radio-phonographs at prices which represent value for the public and profit opportunities for our dealers.



President

FARNSWORTH TELEVISION & RADIO CORPORATION
FORT WAYNE, INDIANA

AGAIN MORE NEW MODELS BY

Farnsworth

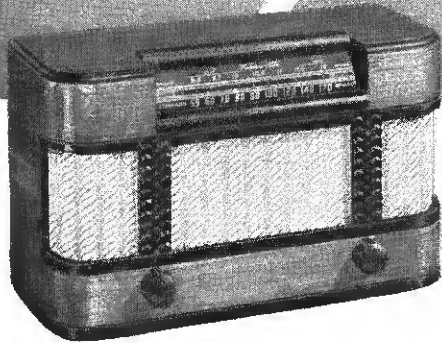

**EVERY MODEL
A STAR PERFORMER
BRILLIANTLY STYLED
NEW PLASTICS — NEW WOODS**

Model CT-54. Here's a 5 tube "super" that will sell itself right off the dealer's display. A leading Farnsworth value in price, performance, and design. Furnished in attractive walnut grains with golden colored grille cloth. Domestic, short wave and band spread.

Model CT-64. The hottest table model bargain in the industry! Sparkling with originality, the contrasting wood and grille cloth give it a charm that appeals to everyone. It's a six tube star performer with domestic, short wave and band spread.

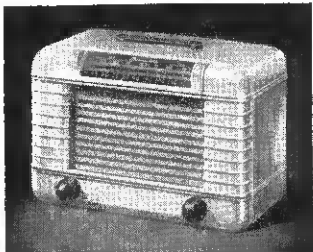

A 5 tube plastic of super beauty! Broadcast, short wave and band-spread. Model CT-52 Mahogany plastic with gold trim or Model CT-53 Ivory with brown trim.

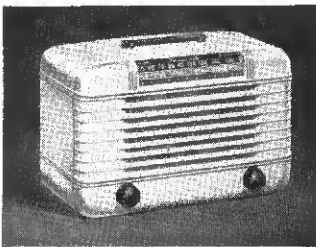

A honey for the money! Here's a value unmatched in low priced 5 tube receivers. Model CT-50 Mahogany plastic and Model CT-51 in Ivory.

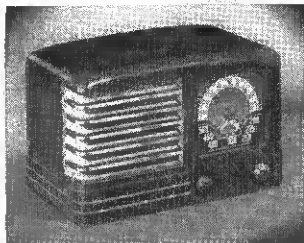

Model CT-43. Here is a dual purpose, low cost radio that is really practical! Battery operated — a tube converts it to AC-DC.

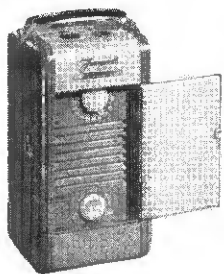

Model CT-59. The popular Farnsworth TRIPLE PLAY radio! Operates on battery or AC-DC current. Another top sales performer that brings in customers.

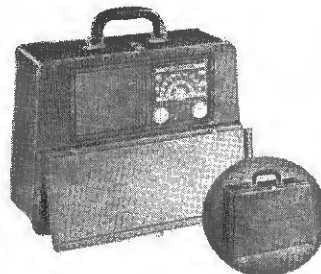

Model CT-60. A beautiful luggage type radio that sells on sight. A far reaching 6 tube set of unusual tonal quality. 3 gang condenser.

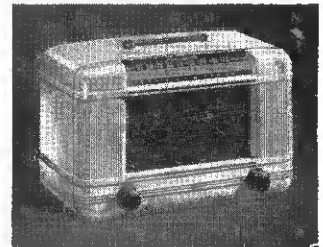

A superb 6 tube receiver of both superb tonal quality and design. Compact and ultra-modern. Model CT-61 Mahogany or Model CT-62 in Ivory plastic.

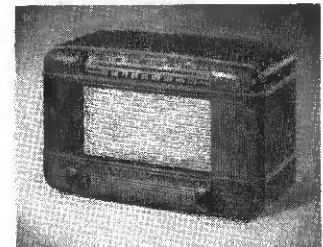

Model CT-63. Another 6 tube set of four star performance! Tone control, domestic, short wave and band spread and a plastic cabinet of Mahogany finish.

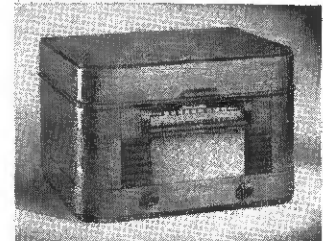

Model CK-58. In eye appeal or car appeal you can't match this five tube combination radio-phonograph. Plays 10 or 12-inch records with lid open or closed.

New Farnsworths Bristle with Sales Opportunities

Keep ahead of the 1942 parade with Farnsworth. Remember, just recently Farnsworth offered two new 1942 portables that made dealers cash registers develop hot boxes. Next came three new battery-operated table models. Now, ahead of the growing procession come eight brand-new 5 tube and 6 tube AC-DC table models. Beauties! Mahogany and Ivory plastics, and also lustrous wood cabinets. Quality, variety, style, band spread tuning and vastly improved performance . . . at prices to fit every customer's budget.

Customers will be looking for these new sales-winners at their Farnsworth dealers. With radio interest at an all-time peak, now is the time to cash in with the newest in radios. Call up your distributor today — or wire, write or telephone Farnsworth Television & Radio Corporation, Fort Wayne, Indiana.

FARNSWORTH

MAKERS OF RADIO AND TELEVISION TRANSMITTERS AND RECEIVERS, THE CAPEHART, THE CAPEHART-PANAMUSE AND FARNSWORTH PHONOGRAPH-RADIO COMBINATIONS

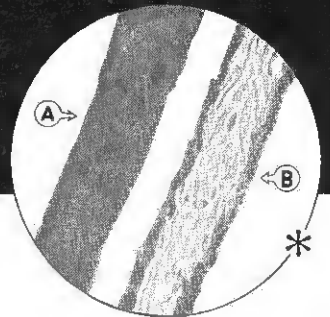
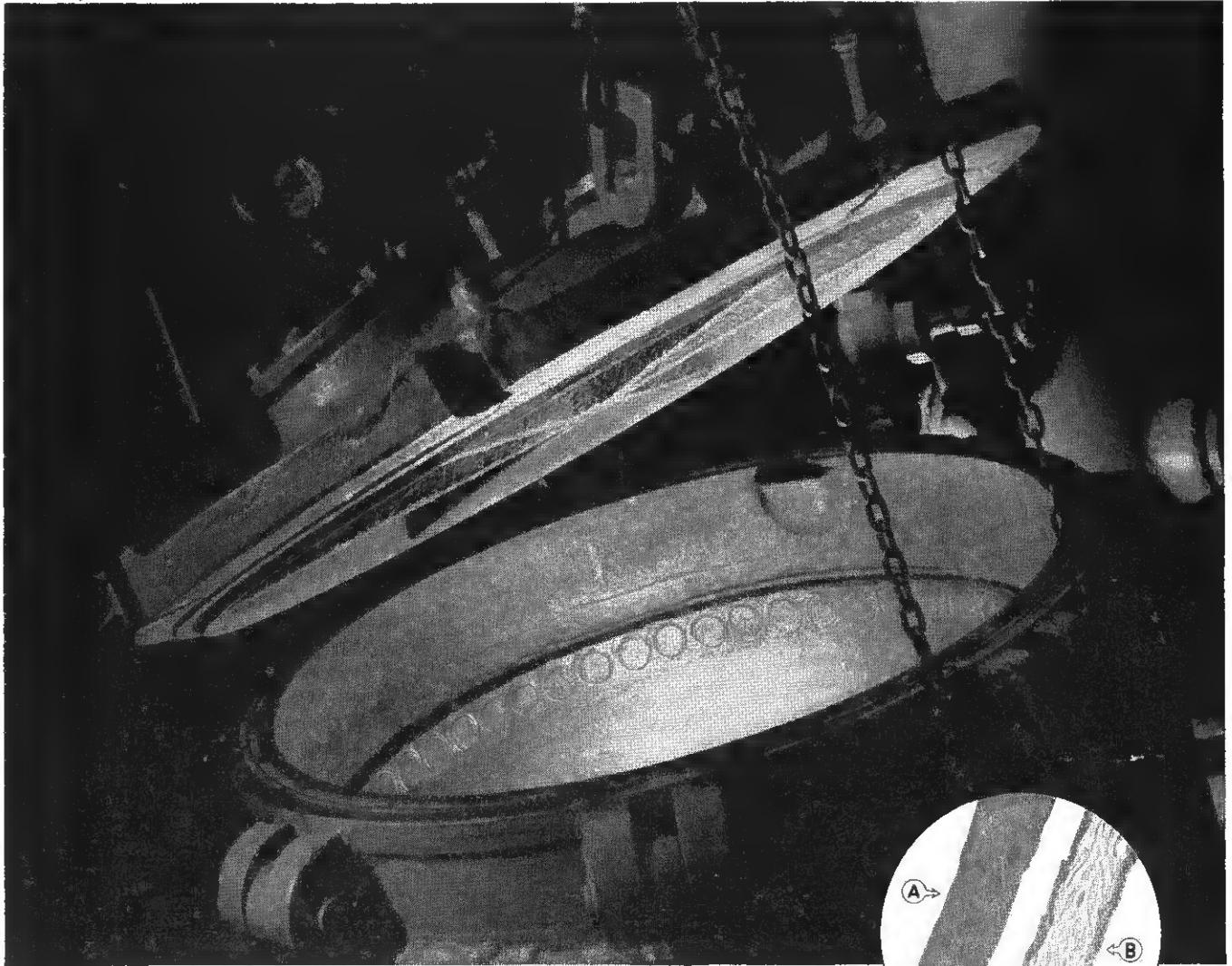

Want to Knock the Breath Out of a Piece of Paper?

IT'S done nearly every day, in the Utah factory, as an extra precaution against transformer failure in the field. One of the most common causes of failure in ordinary transformers is due to inadequate protection against moisture.

In these torture chambers, Utah Transformers, encased in layers of specially made, moisture-resistant paper, are heated under a vacuum for hours. Thus, all of the air is safely removed from the paper and all of the moisture is evaporated. Only then is the molten wax drawn into the vacuum tank and forced into the emptied

cells of the paper under high pressure. As a result, an interlayer insulation is obtained which is impervious to moisture.

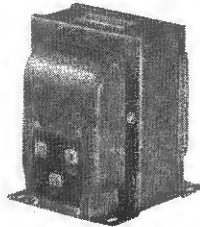

This is but one of the reasons why Utah Transformers have established such outstanding records, even under severe conditions. And why they offer you extra value. Write for the facts about Utah's complete line of transformers. Utah Radio Products Company, 810 Orleans St., Chicago, Ill. Canadian Office: 560 King St., W., Toronto. In the Argentine: Ucoa Radio Products Company, S. R. L. Buenos Aires. Cable Address: Utraradio, Chicago.

*500 X enlargement of cross section of interlayer insulating paper showing advantages of (A) Utah's vacuum-pressure, complete impregnation over (B) ordinary hot-dip, surface coverage method, in which air and moisture remain in cells.



TRANSFORMERS
SPEAKERS • VIBRATORS • UTAH-CARTER PARTS



**On the night flight from coast
to coast American Airlines
depend on RAYTHEON tubes**



Roaring out of the west comes the pride of the American Airlines on the night flight to the East coast . . . the President is on the air! . . . there is news from Europe, important news! . . . passengers listen attentively—for American Airlines in keeping with their tradition of the latest and best in equipment—provide radio; and of course they choose the dependable RAYTHEON TUBES as standard equipment.

Servicemen and dealers, as well as airline engineers, know they can depend on RAYTHEONS to faithfully perform whatever task is assigned to them. That is why sales of RAYTHEON replacement tubes have been steadily climbing for five years. Try it yourself . . . make your next tube order RAYTHEONS! And remember, RAYTHEONS cost no more!

Your RAYTHEON distributor can tell you many more reasons . . . see him today!

NEWTON, MASS. NEW YORK CHICAGO SAN FRANCISCO ATLANTA

WORLD'S LARGEST EXCLUSIVE RADIO TUBE MANUFACTURERS

NEW TABLE MODELS

*Look at the prices! Check the specifications! We don't believe that you'll find better table model values than these—anywhere!

Here is a line that is sure to pace the table model field!

Every model has eye appeal! And every one is a star performer!

Investigate! Get in touch today with the G-E Radio distributor. General Electric Company, Bridgeport, Conn.

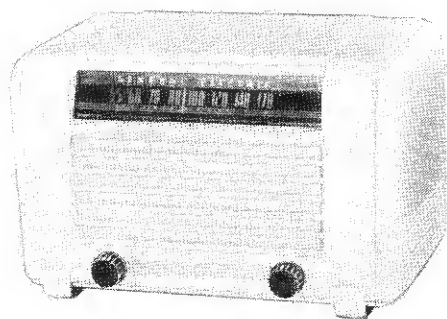

MODEL L-610—In smartly styled cabinet of ivory plastic. Retails for \$19.95*.

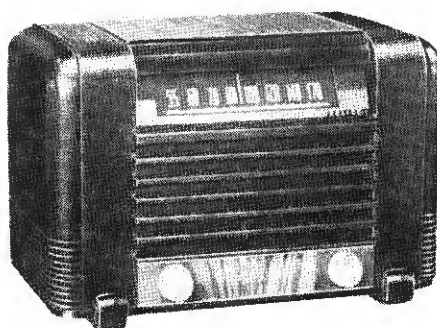

MODEL L-604—In lovely cabinet of two-toned walnut veneers. Retails for \$21.95*.

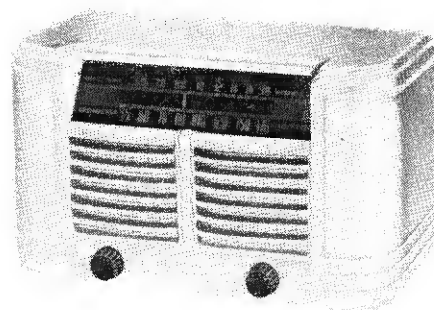

MODEL L-624—Two band set with cabinet of sparkling ivory plastic. Retails for \$24.95*.

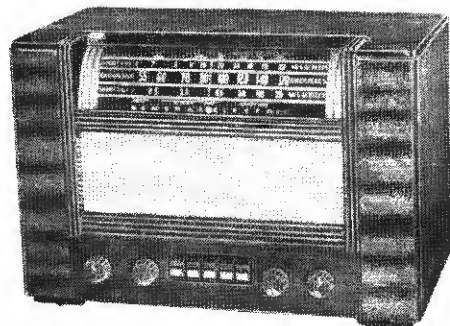

MODEL L-640—Electric tuning keys. Cabinet of walnut and sapeli wood veneers. Straight A-C. Retails for \$44.95*.

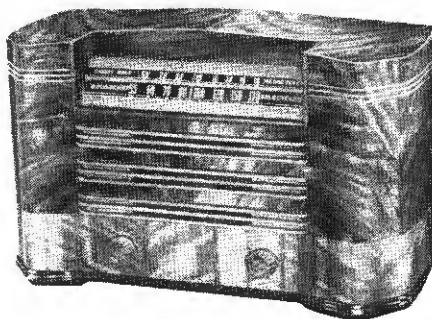

MODEL L-633—Two built-in Beam-a-Scopes. Cabinet of beautiful moulded walnut veneers. Hand-rubbed piano finish. Retails for \$39.95*.

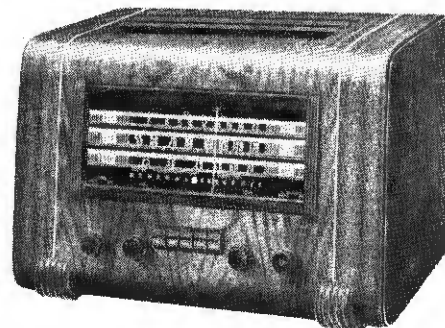

MODEL L-740—De Luxe model. Finer tone—more power. Cabinet of walnut and mahogany veneers. Straight A-C. Retails for \$54.95*.

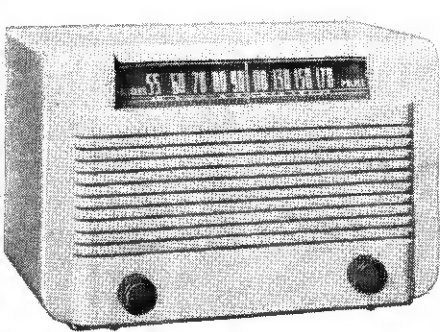

MODEL L-550—In a beautiful ivory plastic cabinet. Retail for \$13.95*.

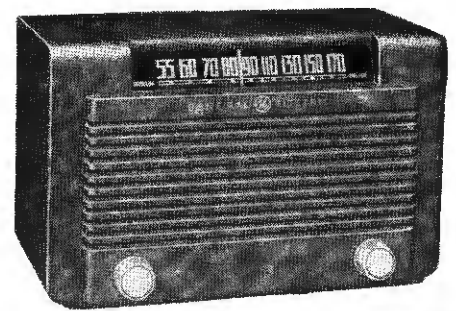

MODEL L-500—Prize-winning cabinet in rich mahogany plastic. Retail for \$11.95*.

AND A NEW SALES APPROACH

All of the advertising and merchandising behind this has been planned with just one thought in mind: To give the consumer the enjoyment of owning an extra radio set. That's the sales approach that is sure to help you round up new table model business.

Selling Aids to Help You Sell!

NEW TABLE MODEL MERCHANDISER—(Illustrated). Unique—colorful—effective! It takes but little space yet it does a lot of selling.

NEW CUT-OUT DISPLAY CARDS—(Illustrated on Merchandiser). Put them in your windows. Place them on your counters. They're bright and colorful, and they start sales because they start ideas!

NEW NEWSPAPER MAT BOOK—Ready-made ads with cartoon and human interest illustrations.

NEW POSTCARD MAILING PIECES—Colorful cards with an amusing cartoon treatment. You can put them to work for very little cost.

NEW TABLE MODEL BOOKLETS—Sparklingly new and different. Printed in green and black.

NEW RETAIL SALESMEN'S PORTFOLIO—Ring binder with loose-leaf pages showing illustrations and specifications for all G-E 1942 Radios.



G-E RADIO MODELS ON MERCHANDISER

1. **MODEL L-600**—Continental styled cabinet in mahogany plastic. Retail for \$17.95*.
2. **MODEL L-613**—Two built-in Beam-a-Scopes. Two bands. Cabinet in walnut and rosewood veneers. Retail for \$27.95*.
3. **MODEL L-630**—A-C transformer set with plenty of output! Cabinet in walnut and rosewood veneers. Retail for \$34.95*.
4. **MODEL L-621**—Foreign and domestic broadcasts. Cabinet of mahogany plastic. Retail for \$21.95*.
5. **MODEL L-652**—Exquisitely styled cabinet and 5 electric-tuning keys! Retail for \$24.95*.
6. **MODEL L-632**—Foreign and standard broadcasts. Cabinet in rich American walnut veneers. Retail for \$29.95*.



THE RAINBOW OF SOUND



Good-bye, Needle Scratch!
Crosley Invention Answers
Public's Long-felt Desire

THE FLOATING JEWEL TONE SYSTEM

(Patent applied for)

opens way for greater sales of Combinations
—which are already outselling Consoles.

Only **CROSLEY** has it!

Good-bye, surface noise,
hissing and chatter!

NO NEEDLES TO CHANGE

EXCLUSIVE! PATENTED!
SENSATIONAL!

With a tone-arm firm enough to sustain even performance, yet so perfectly balanced that even dropped on a record or scraped across it causes no damage—

Permanent sapphire is newly designed and plays in parts of the groove which other needles have never touched—where pure music originates! Wider radius does it! Rediscovers the delights of older records!

“Gets Europe” Direct — \$14.95

Model 52-TD does it!

And you know what that means *this* year with World Events sending the American public to their radios—wanting European broadcasts quick, clear and direct.

Master Tone-Control

with over sixty combinations of highs, mediums and lows—lets every listener suit his own tone-taste. Gives the listener more than he has ever been able to get out of a radio set before! Blends and amplifies—like sitting at the studio controls.

Table models, Consoles, Combinations— all in beautiful, lustrous cabinets, with a sheen of matched woods, larger dials, packed with flash appeal! Glorious value in every line! See your Crosley distributor before you place any order for radio sets.

CROSLEY

*Prices slightly higher in far west and south.
Prices and specifications subject to change without notice.

THE CROSLEY CORPORATION, CINCINNATI, OHIO
POWEL CROSLEY, JR., Pres.

HOME OF WLW, “THE NATION’S STATION”
70 ON YOUR DIAL

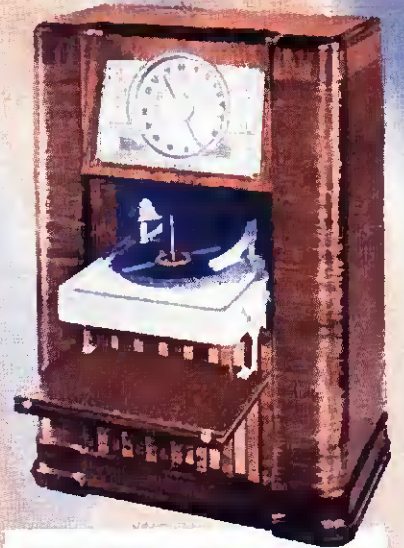

Model 02CP. Radio-Phonograph with automatic record-changer—Patented Floating Jewel Tone System gives records longer life—new life to old records. 10-Tube AC Superheterodyne with “Rainbow of Sound” and Master Tone-Control. 3 complete bands and FIVE TIMES GREATER PICK-UP.

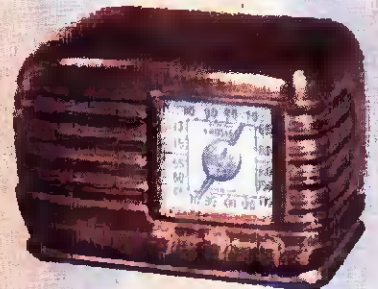

Model 52TD. More than the usual two band set. Complete reception 19 through 49 Meter Band. A 5-Tube AC-DC Superheterodyne with beam power output, automatic sensitivity control, big full-view illuminated dial, cabinet is of genuine brown-mottled bakelite.



Model 02CA. Five times more pick-up. More than 60 tone variations by merely pressing the buttons of the exclusive Crosley Master Tone-Control. A 10-Tube AC Superheterodyne with 12-Tube performance. The lustrous lovely cabinet has large, clear-vision dial.

Keep Your EYE *On PROFITS*

Net is the Mark Dealers Must Shoot At During the Emergency

GUESSTIMATES pegging probable 1941 radio production as low as half that of last year are being vociferously voiced by those who for one reason or another prefer to look on the seamy side of the set business.

They are obviously exaggerated, in view of actual shipments during the first half and the fact that while all manufacturers are admittedly experiencing difficulty securing materials for future schedules most say they will be able to get through the third quarter without serious curtailment. A few think metals in warehouse or substitutes may postpone the necessity for major cuts still longer.

PRODUCTION will undoubtedly be less this year than last but not nearly so much less as pessimists with, perhaps, a purpose would have us believe.

Any reduction will nevertheless be sufficient to alter the nature of the industry's target. The manufacturer's chief objective will be to spread civilian equipment as equitably as possible rather than feeding it to "wheels that squeak the loudest" and by this means, plus continued institutional promotion, hold his best distribution today and improve it for tomorrow. The distributor's aim will be similar, successful management during these transition times being measured more by the soundness of accounts than any possible cash reserve.

DEALERS may by late Fall find themselves in a less complicated but equally critical position.

Their problem will be to make a livable profit from fewer unit sales and, possibly, smaller dollar volume. This can be done only by selling better sets, both large and small. More net must

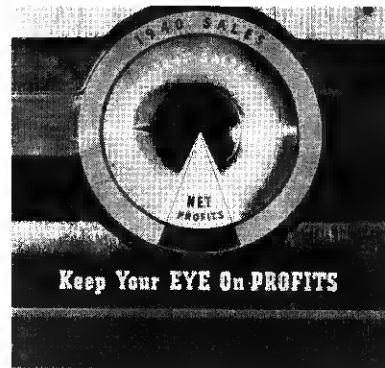

be extracted from each transaction and "selling-up," until now largely an editor's dream, must become general practice for self preservation.

This is the time to wipe out the consumer impression that a radio list is just a place from which to start chiselling, the time to wean the public away from the idea that trade-ins are worth their weight in discounts, to whittle off losses caused by volume-crazy credit, free installations and service.

These things won't be done if the trade shortsightedly slices off salespower as deliveries tighten. Under such circumstances the need for salesmanship is, in fact, greater than ever, "seller's market" or no seller's market.

It takes a real man to keep his eye on an employer's profits.

Any sap can sell "deals."

W Mac Donald

Editor



FINE VACATION FEATHERS

Snappy luggage does a girl no harm when she entrains for the summer spots and portable radios like this Philco are certain to enhance her popularity when she gets there. It'll do no harm to delicately point this out to femmes passing your window

PHOTO *Shorts*

Pictures *from the News*
to help you SELL



DEALER RUNS STREET DANCE

When Hannibal, Missouri, celebrated the opening of the \$3,000,000 "Mark Twain Bridge" linking it with Illinois, the William C. Henn Electric Company sent out 12,000 postcards inviting the people of two counties to enjoy a street dance in front of the store. 8,000 showed up in an 8-hour period, shook a foot to amplified recorded music, accepted circulars from salesmen circulating in a roped-off 200-foot space



NEW ENGLAND INNOVATION

Installed in this Salem traffic-control booth by Hytron engineers, a 12-watt sound system passes pedestrians and motorists a surprise. When either violate signals the cop issues a warning. Note mirror on Turner mike support to give him "eyes in back of his head" and University speaker over signal light

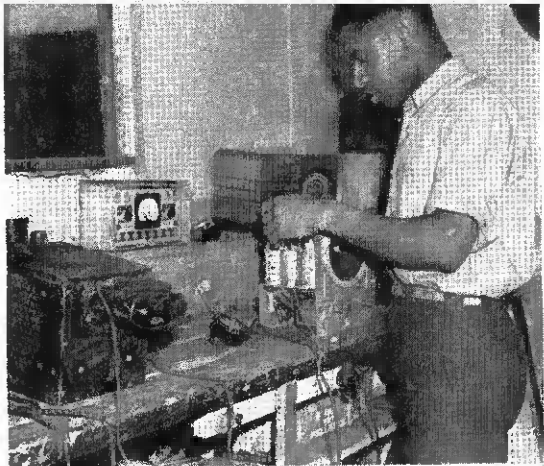

INGENUITY IN THE DEEP SOUTH

Pine slabs, nailed over what used to be just a rough board shack, glorified this service shop down in Birmingham, suggested a new name. Cleo Fowler is now the proud proprietor of Log Cabin Radio

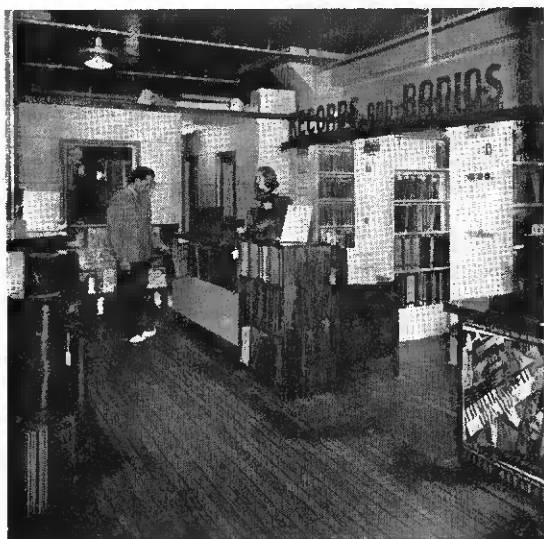
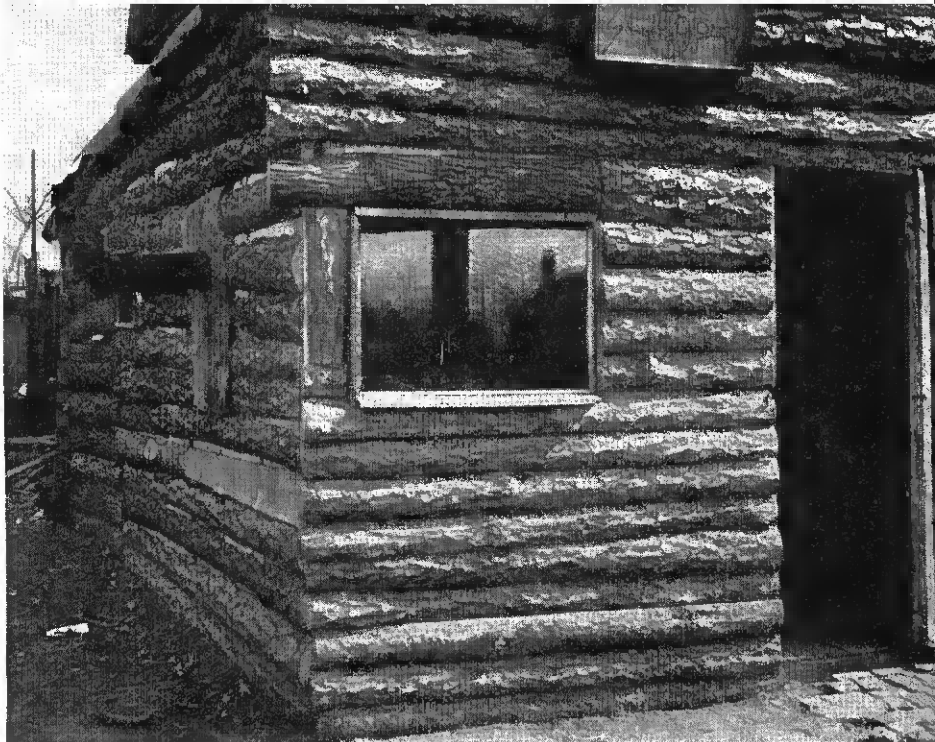

LEAVES THEM ALONE TO SELL SELVES

When customers ask about combinations at J. K. Gill's out in Portland, Oregon, they are ushered into one of six soundproof demonstration booths, left alone for five minutes to tune. Then a salesman wanders in and listens to the radio too, finally asks what record the customer would like to hear, gets it, remains silent while it plays. By the time actual selling starts the prospect has virtually sold himself



RADIO IN EVERY ROOM

Specialty of Memphis' C. A. Pinson is repeat business. Even when he closes a cash sale he records the name and address. Customers are maneuvered near the cutaway house display, Pinson's pet dealer-help, rarely get away without hearing him laud the virtues of several sets per home

CLASS CORNER

L. S. Ayres & Company of Indianapolis demonstrates how period furniture model radios are best displayed, wallpaper backgrounds, rugs and comparable furniture setting them off



SOUND GOES TO A FAIR

Two Atlas projectors in the upper corners of the judge's tower at the Altamont Fair did a good job of covering racing and trotting events for Montross Sound of Troy, N. Y.

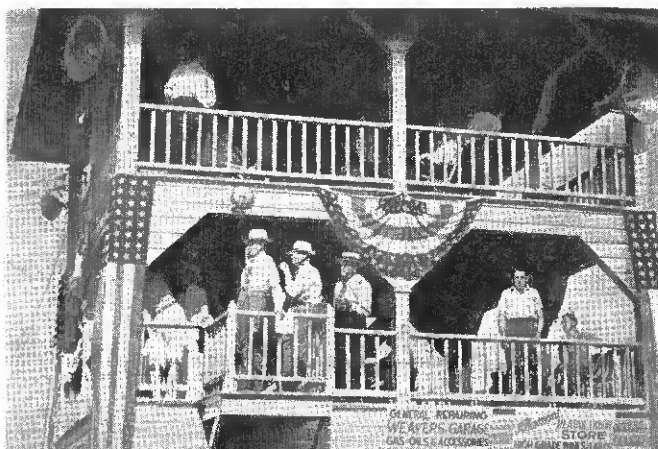

More



Latest *Wilcox-Gay* machine covering the airlines, playing records automatically and recording, boasts tilt-front tuning and dual-speed turntable

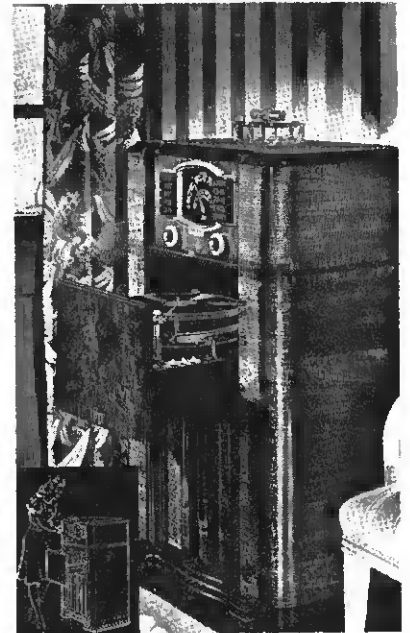

"Phono-Glide" for easy disc loading highlights this new *Zenith* combo

Combinations

SINCE last month's initial preview of new radio models for 1942 a sufficient number of large sets, particularly, have made their debut to give a better overall picture of what the trade will have to "sell up to" in the months ahead.

At this stage it is apparent that many manufacturers are pivoting their lines on combinations, that a dominant feature in such sets is the slide-out or pull-out or tilt-out automatic record player. Noted also is emphasis upon lightweight and otherwise improved tone arms, more refinements and conveniences in disc-playing machines. FM obviously moves up out of the "swaddling clothes" stage.

Brunswick Radio's 1942 line

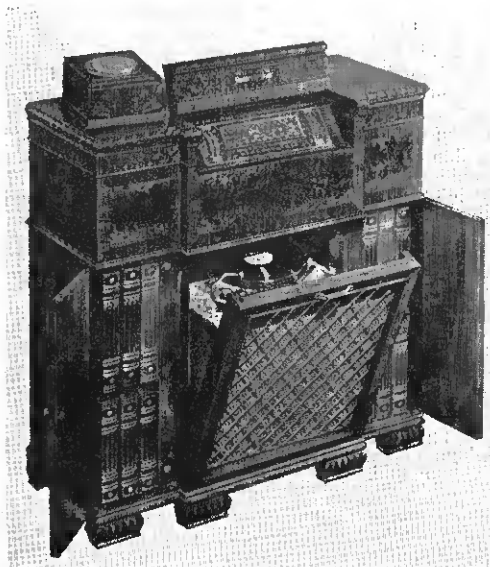

Philco's top model features AM-FM "drop-away" distinguish this *Crosley*

Philco's top model features AM-FM tuning, wireless remote control

New MODELS

COMBINATIONS . . . CONSOLES . . .

FM SETS fill out popular 1942 radio lines

starts off with five new models. All are combinations and are inclosed in authentic reproductions of traditional furniture. For the first time, several models in this line are equipped for FM reception. "Panatropé" automatic record changers incorporate special low-pressure pickup with permanent needle. A special pre-amplifier stage is used to minimize surface noises. All cabinets open from front. Prices range from \$179.50 to \$300. New line was previewed by metropolitan dealers latter part of June at company's New York offices. Plans call for introduction of four more models in early fall.

"Floating Jewel"

Crosley, at its New York convention early in June, introduced two new combination consoles, 82CQ and 02CP. Both feature "Floating Jewel Tone System," slide record player with new changer capable of playing 10 and 12-inch discs. 82CQ employs 8 tubes and covers 2 bands from 550 kc to 18 mc. Model 02CP is a 10-tube set covering 3 bands from 540 kc to 18 mc. Has an 8-inch diameter airplane style dial and a new tone control with six tone buttons providing more than 60 possible tone combinations. Price \$119.95. Also included in new '42 line is an 82CP combination, two straight consoles and two more table types in addition to compacts and portables described in *Radio Retailing* June number.

Emerson, at its recent advance showing for eastern distributors, introduced a wide range of new models from "Personals," 3-way portables and compact sets to a completely new "Phonoradio" line of portable automatics and a 20-watt console combination. Included in the advance line are compacts 413 and 421, both employing an

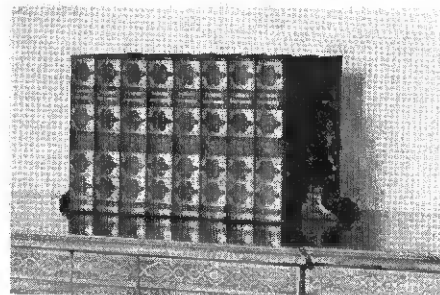

FM "translator" by General Electric is cleverly disguised as a set of books



This one, of two table types by Philco, tunes AM and FM, lists at \$49.95

Frequency Modulation

illuminated slide-rule dial, a brand new portable at \$19.95 and a slick looking table automatic phono-radio model No. 437.

FM Translator

Fada starts the ball rolling with announcement of six new record players and two portable phono-graphs. Line includes two wireless playing units and a 3-tube automatic changer model. Also, just released, three table sets (220 series) to operate from either a.c. or d.c. supply. All three utilize 5 tubes.

Included in *General Electric's* line is a new FM translator, No. 12.

It is cleverly disguised as a series of books, for placement on top of console or in bookshelf. Equipped with 6 automatic tuning keys in addition to manual control. Uses 9 tubes. To retail for \$69.95. A series of previews are currently being held throughout country on new table types, consoles and combinations.

Sixty Two Models

Philco announces a total of 62 models in its 1942 line, consisting of straight radio consoles, combinations, farm sets and portables. Highlight of many improvements

COMPLETE Picture

FEATURED in June were Compacts, Portables and Farm receivers. This month we "mop up" on small types and conclude with larger models, as promised. Sets still to be announced will be described, as usual, in New Merchandise Preview columns of coming issues

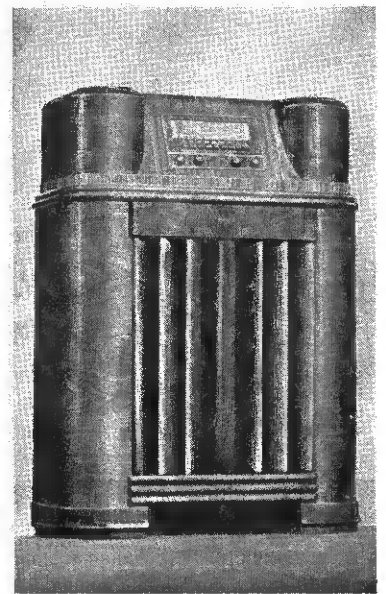
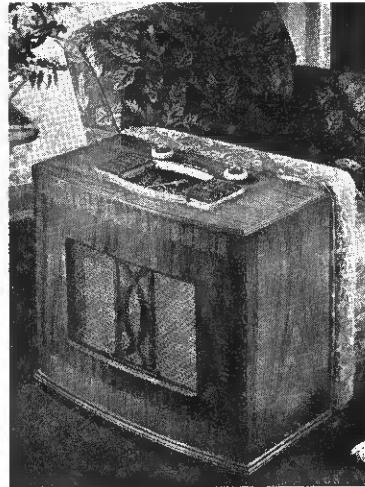
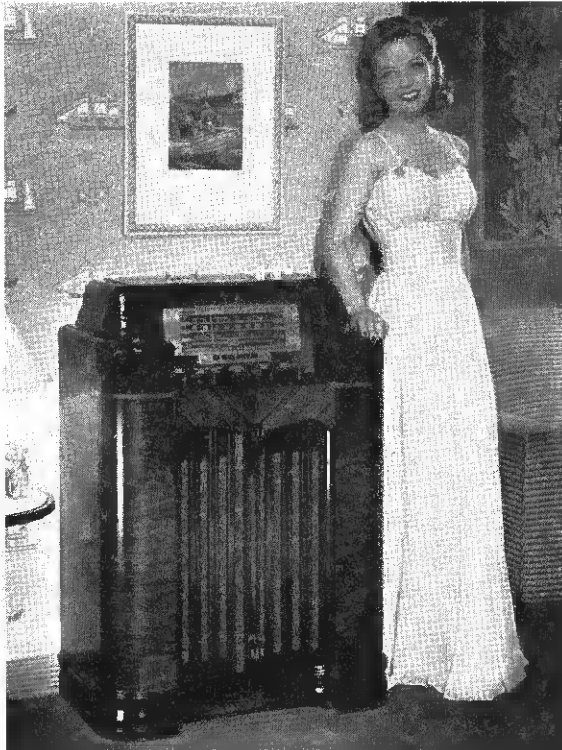

Latest chairside (above) by Zenith has 6 tubes and a "wavemagnet"

RCA 29K2 (left) has "Floodlight Tone," "Studio Controls," phono plug and switch

AM and FM are both covered by pushbuttons in this new Philco

Consoles

offered is the announcement that nine models provide FM as well as AM reception. (See circuit elsewhere in this issue.) Included in this FM series are two table types, 355T at \$65 and model 350T at \$49.95. Latest developments in record-playing models include a new stroboscope pitch and tempo control, variable speed motor especially valuable for recording and a particularly compact new automatic changer with fast acting switch. There are also six farm sets with built-in aerials and 1½ volt type tubes.

RCA Victor, just before press

time, supplements advance information furnished us last month with the advice that it will have eight new table type sets instead of the four originally proposed, one of them incorporating record-playing (all compacts have phono attachment connections) and another, "Floodlight Tone." The last mentioned feature, it now becomes evident, involves a second speaker of the high-frequency variety, equipped with a connection plug which may be readily removed to audibly "demonstrate the difference." It is simultaneously learned that there will be a new electrified portable

Victrola with storage space for 10-inch records, available in blue or black simulated leather, and an "Electrifier" accessory containing a tube and permitting five farm models to be converted to ac operation by merely inserting battery cable plugs into the device and connecting the latter to the line.

Sonora sets not previously covered include a new compact model KM450 at \$19.95, and a low-priced phono-player, KW152, listing at \$22.95. Compact employs 5 tubes and is designed for both a.c. and d.c. operation. Portable electric phonograph has a 2 tube amplifier, crystal pick-up and plays both 10 and 12-inch records. Case is covered in brown luggage-cloth.

Portables

Stewart-Warner's latest portable contains a dry battery charger

Just a handful is Emerson's three-way "Power-Mite" portable

This new triple-powered set by Westinghouse has beam-power output

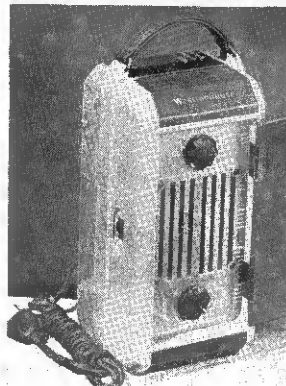
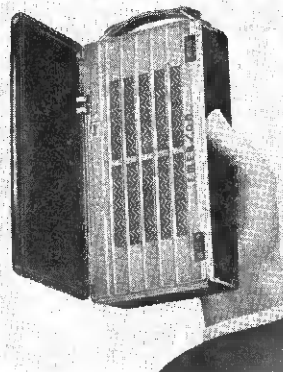
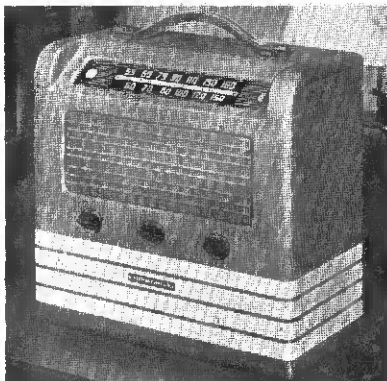

Battery Charging Portable

Stewart-Warner has three self-charging portables featuring a new circuit arrangement designed to rejuvenate dry batteries used in these sets. Besides battery operation, all three also work on both a.c. and d.c. supply. S-W claims that a single recharge is sufficient to operate one of these sets on battery supply for a normal two-week vacation period. List from \$29.95 to \$39.95. Twenty new home sets scheduled for early appearance.

Wilcox-Gay "Recordio" line for
(Continued on page 52)

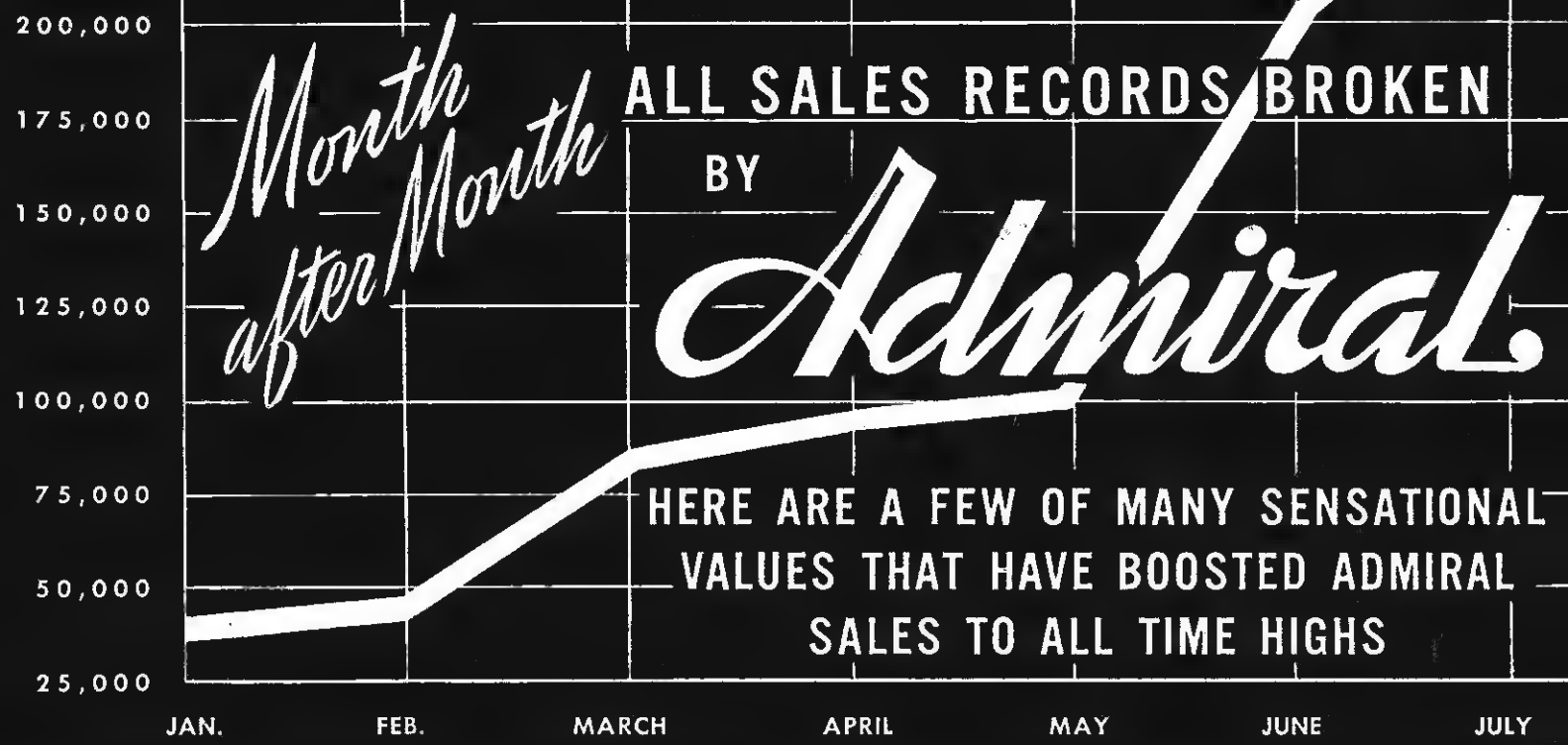
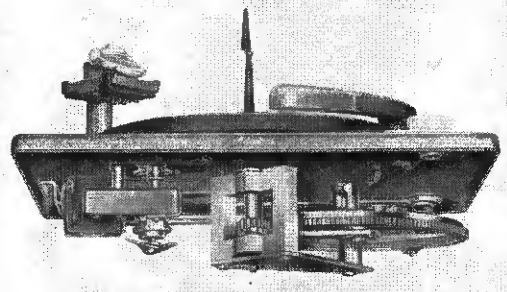

TABLE MODEL PHONO-RADIO COMBINATIONS WITH AUTOMATIC RECORD CHANGER



MODEL 69-M5—The lowest priced phono-radio with A.R.C. on the market! 5 multi-purpose tubes; superheterodyne radio has super Aeroscope; beam power output; full size heavy duty P.M. dynamic speaker; automatic volume control; "Sofglo" dial. *New audio circuit developed by Admiral produces tremendous power.* Covers standard broadcast band (540 to 1630 KC). Automatic record changer, designed and built by Admiral, plays twelve 10" or ten 12" records. Equipped with Admiral "Lifetime" Needle. No needles to change . . . no record wear. Attractive **\$42⁹⁵** walnut cabinet.

ADMIRAL-BUILT RECORD CHANGER HAS MANY EXCLUSIVE FEATURES



Today . . . Admiral is the largest manufacturer of automatic record changers in the world. Here are a few features that explain why: Only 210 parts (half the number found in others); changing time cut to 6½ seconds; pick-up pressure reduced to 1 oz.; speed variation due to loading of turntable reduced to ¼ RPM (2¾ RPM on others). Actual tests show Admiral "Lifetime" Needle maintains uniform groove-fitting radius required for perfect pick-up after 10,000 continuous playings.

MODEL 70-N6—The finest table model phono-radio in performance plus appearance on the market! AC superhet; tunes 545 to 1630 KC. Has 6 multi-purpose tubes; variable tone control; bass compensation; 6" P.M. dynamic speaker; automatic volume control; super Aeroscope; high power output; smartly styled walnut cabinet. Admiral-built automatic record changer plays twelve 10" or ten 12" records. Equipped with Admiral "Lifetime" Needle. No needles to change . . . no record wear. List price only **\$54⁹⁵**

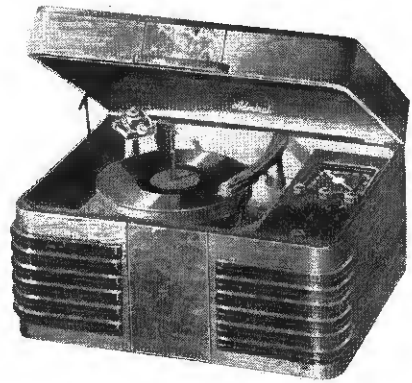

Admiral Record Cabinets in Special "Deal"

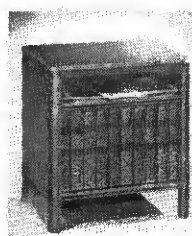

Designed to harmonize with table models shown at left. Has compartments for 8 record albums. Sold complete with five 10" albums at a sensational price when purchased with an Admiral radio-phonograph.

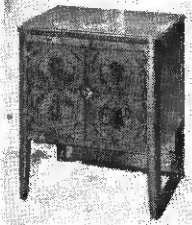

THE PICK OF THE PORTABLES — THESE 3-WAY (AC - DC OR BATTERY) RADIOS BY ADMIRAL

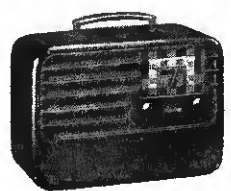

76-P5—5-tube AC-DC plastic home set and portable, \$22.95

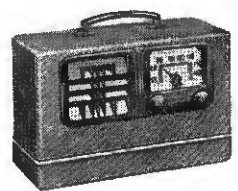

77-P5—5-tube AC - DC tweed portable, \$24.95

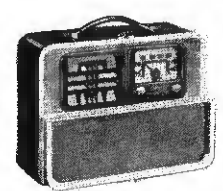

78-P6—6-tube AC - DC portable, \$29.95

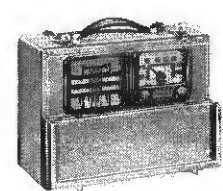

79-P6—6-tube AC - DC deluxe portable, \$32.95

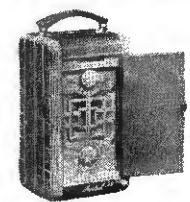

29-G5—AC - DC Battery "Bantam" \$22.95

All prices slightly higher in Far West and South, subject to change without notice. Admiral Radios are equipped with RCA preferred type tubes. Originators of Tilt-Tuning, Touch-O-Matic, Aeroscope, Slide-A-Way, AC - DC - Battery Bantam.

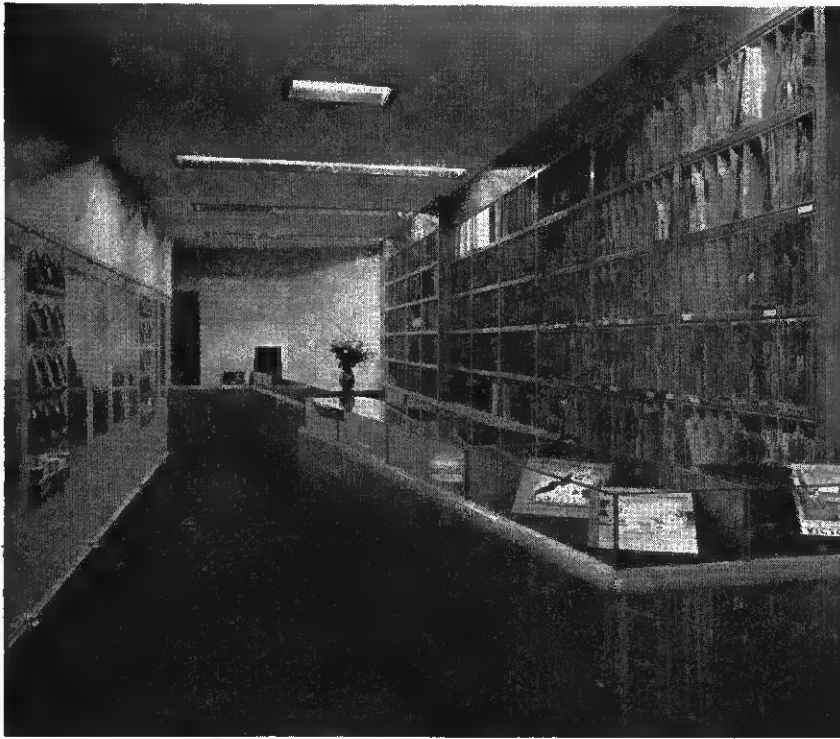

SWANKY SETUP—This interior view illustrates record booths on left, record stock and counter on right, fluorescent lighting

RECORDS by Phone

MAGNAMUSIC Record Shop, New York City dealer, has instituted a novel method for merchandising records that should have unusual interest for the entire trade.

The manager of the store calls it "Record Sales by Phone" and says the plan does 3 things: speeds purchases, saves wear and tear on discs and makes sure they are properly played.

This is how it works. The store is equipped with 4 booths. Each one measures 5 by 6 feet. Within each booth there is a small table and a "house" telephone, a concealed loudspeaker and seating accommodations for 3 people. The usual record player is absent.

The customer enters a booth, picks up the telephone (connected to central phone at counter) and tells the clerk the name of the desired selection. The clerk proceeds to play the disc requested on one of four turntables installed in the glass inclosed counter. These turntables are connected through individual amplifiers to the concealed speakers in the booths.

Aside from its unique method of merchandising, the store itself strikes a de luxe note in design. It is illuminated by recessed fluorescent lighting. Counters and record racks are finished in natural mahogany.



MUSIC UNDER GLASS—Shows the four turntables. Phone lines and sound equipment complete link to booths

Quality

By

W. CARL DORF

"SELLING 'quality radios' requires a special technique," says W. G. Barrow of Barrow Music Shops, Great Neck, Long Island. A "hit or miss" sales plan is n.g. for the higher-priced merchandise and can only result in loss of upper-bracket business to the nearest competitor.

Barrow, with 17 years of radio retailing, is well qualified to speak on the subject. He opened his first store in 1924 and from the beginning has preached "de luxe" instruments for the best in radio and records. Seventy-five percent of his business last year was done in models which averaged \$150. And in the same year he made 10 remote-control installations bringing an average price of \$900.

These figures take on additional importance when it is realized that the job was accomplished in a trading area of less than 40,000.

Personnel and Store Appearance

Barrow's clientele is a cross section of middle-class wage-earners and the well-to-do. As he expressed it, his customers meet on the common ground that they are music lovers and both want the best they can afford.

Personnel is evidently very important. Salesmen must know how to talk intelligently about the features of a modern combination receiver. "Dese and Dose" positively taboo. On the other hand, their speech cannot be encyclopedic. Extremes are not tolerated because customers react unfavorably.

The sales force must be well dressed as well as neatly dressed. This point cannot be overstressed.

Store appearance is tied in with a quality sales policy. As the prospect enters, the store's rich yet conservative appearance hits him square in the eye. This provides

Sales Take Technique

THERE'S a trick to it, mastered by this dealer with 17 years of experience, reporting 75 per cent of his business above the \$150 mark last year

COMBINATION, HALF SOLD
—Barrow goes into his act

MANY SALES START HERE—
The Barrow record counter

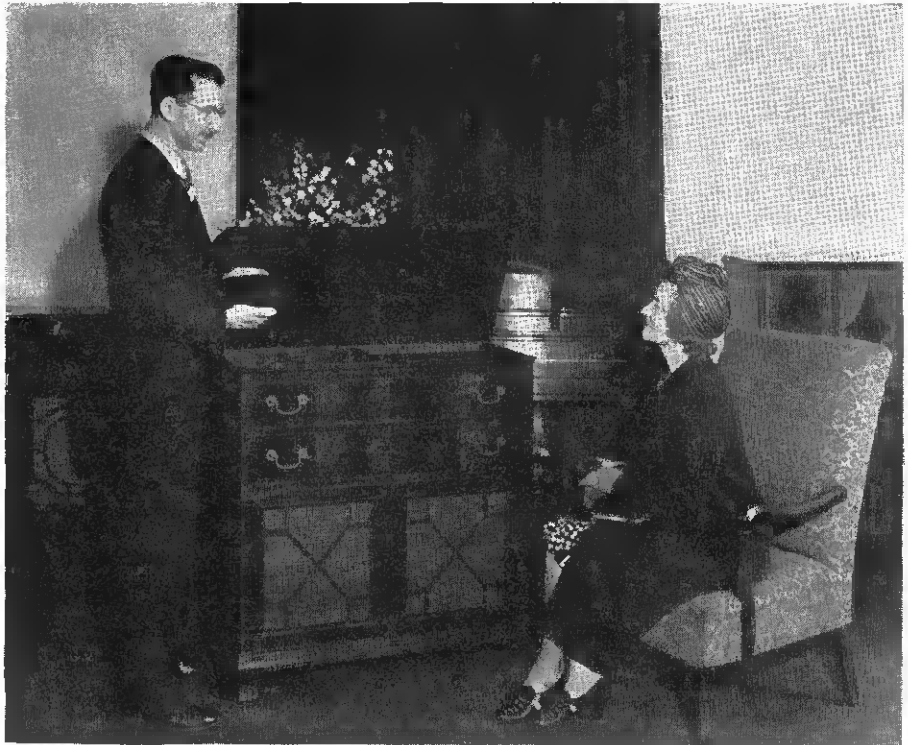

an opening wedge to present top-flight merchandise.

Window displays are similarly styled, remain on duty day and night. People still inspect the Barrow windows long after the store is closed and their good taste brings prospects back.

Salestalk Suggestions

Salestalk delivery can make or break an opportunity to sell-up. There is no excuse, however, for an intelligent salesman to flop on

this point. Barrow says that the modern receiver offers numerous opportunities. For instance: a man can now legitimately stress fine cabinetry, automatic phono playing and "quality" reproduction. Often the latter is the No. 1 selling point for combinations.

This dealer says: "Know records and be enthusiastic about recorded music. It's a big help in closing sales." Barrow has spotted many prospects for quality models at his record counter. It is his conten-

tion that any person interested in classical recordings is a definite prospect for a combination. He encourages disc customers to talk about their record libraries and, in addition to stepped-up record sales, this very often paves the way for a receiver demonstration.

"So," says Barrow, "demonstrate quality reproduction to record customers. Emphasize what a new combination can do. Follow this up with an audition of prospect's favorite selections. Demonstrate the radio and other services, of course, but let records do the main job. If you have the right instrument your prospect will become a customer."

Barrow, in closing, comments that in all his 17 years of business he has avoided using high-pressure. It's "out" as far as he is concerned. Sells customers what *they* want and gains satisfied patrons.

LOOK THE PART

TO SELL topflight sets the store, its windows and salesmen must radiate "class" without being "snooty"

News About Two BABIES

Frequency Modulation

THE closing days of June found a total of 50 FM stations authorized to go commercial by the Federal Communications Commission. Of this total 14 were already "on the air." The remaining 36 are in the course of construction, or waiting for delivery of their transmitters. About 60 additional applications awaited Washington action.

On June 17, New York City received three additional FM station authorizations, thereby making a total of eleven FM transmitters authorized for the New York area. Details of the new grants are as follows: W59NY, Interstate Broadcasting Co., (WQXR), 45.9 mc., area 8500 sq. miles. W47NY, Muzak Corporation, 44.7 mc., 8500 sq. miles. W35NY, Municipal Broadcasting System, 43.5 mc., 3000 sq. miles. In addition, Washington, on this same date, approved another FM station for Los Angeles, granting application to the Standard Broadcasting Co.

FCC reports that applications for FM broadcast stations in New York City exceed the number of available frequencies for operation in that locality, is considering establishment of a North Jersey service area, making certain reallocations. The proposed new arrangement would allow New Yorkers a greater number of stations to choose from.

As a stimulus to the development of non-commercial, educational stations in the FM band, an offer has been made by Major Edwin H. Armstrong, to waive the usual royalty fees on the use of his FM patents by such non-profit stations, allowing them to proceed for a royalty fee of one dollar. Major Armstrong communicated the offer to Dr. John W. Studebaker, U. S. Commissioner of Education. Last year the FCC set aside 5 channels for the exclusive use of educational stations (42.1 to 42.9 megacycles).

It is also reported that frequency modulation is being adopted by the Cleveland Railway Co., to facilitate operations on the city transit system. Two-way FM cars will patrol the company lines and report traffic conditions.

Television

THE Radio Corporation of America, on June 16, announced that the National Broadcasting Co., had filed applications with the FCC for three commercial television stations.

New York station, W2XBS, located on top of the Empire State Building, has been on the air experimentally since June 1936. Subject to approval of the FCC, it will be ready to operate on a commercial basis July 1. The fifteen hour program service specified by the Commission as a minimum weekly schedule will provide for broadcasts at periods between 2 and 11 p.m. for at least six days each week.

Application was simultaneously filed for modification of the construction permit and extension of time to complete installation of the NBC's television transmitter W3XNB, Washington, D. C. Permission was requested to operate it on a commercial station basis when completed.

A location has already been selected in Philadelphia for the third NBC television station, and application has been filed with the FCC for approval of its site.

At the same time RCA announced that it will adjust without cost to owners, distributors or dealers, all RCA television sets in the New York area, to conform with the new standards.

(Without benefit of formal notice it is reported in tele circles that the FCC has already okayed the above commercial applications for all 3 cities.)

Word has been received of the formation of the "American Television Society," a non-commercial, non-profit group planning to function as a clearing house for the exchange of television information and ideas. It was explained that the new organization has been in operation for some time but has held off formal announcement of its functions.

Don Lee's new television transmitter, W6XAO, atop Mt. Lee out on the Pacific coast, is said to be completed and, as far as is known, ready for operation on July 1. Further reported that this station is planning an ambitious program schedule.

Columbia Broadcasting System (W2XAB) has received authorization to conduct television program tests for at least 30 days starting July first. Upon completion of tests, CBS expects to receive a commercial license.

Broadway gossips see the advent of commercial television on July 1 opening up a new era in the live talent field. Say new industry will create a big demand for all kinds of stage and screen artists.

Service

ESTIMATING

QUOTE a man a fair price for work his radio repair needs and let him get a lower figure from you by cutting all the corners and you are a "robber"

By a RADIO REPAIRMAN
who thinks it's about time some
body hit their hair down . . .

LONG HOUSE, business houses and other organizations have had many years of experience in the radio repair business. They have learned the hard way that the only way to succeed is to give the customer what he wants and what he needs. They have learned that the only way to get a good reputation is to give the customer what he wants and what he needs.

WHEN a GUY buys a radio he expects it to perform. It doesn't matter how big the store is, but he expects to get his money's worth. He wants a radio that will give him the best service and the best value for his money.

THE AVERAGE independent radio repairman makes \$22.85 weekly, or about 10 to 12 hours a day.

Introduced in Business . . . \$1246
Annual Gross Volume . . . \$4238
Tools and Parts Cost . . . \$1793
Annual Overhead Exp. . . \$1208
Annual Net Income . . . \$1246

5250. You are more a robber to the customer. It is the shop that gives the customer what he wants and what he needs.

The Best Radio Repairman is the one who gives the customer what he wants and what he needs. He is the one who gives the customer the best service and the best value for his money.

THE AVERAGE independent radio repairman makes \$22.85 weekly, or about 10 to 12 hours a day.

Introduced in Business . . . \$1246
Annual Gross Volume . . . \$4238
Tools and Parts Cost . . . \$1793
Annual Overhead Exp. . . \$1208
Annual Net Income . . . \$1246

By JIM KIRK

Manager, Home Radio Service Co.

THE TEAR-JERKING story told by "A Radio Serviceman" in the May issue cries for an answer. I can not understand why "the local boys" were blind to the obvious solution. Nor can I understand why they took the "hard way."

Why bother with scratching an estimate code letter on the chassis? In my shop I have a large sign reading: "Minimum Charge, Inspection or Service—\$1.50." Right next to this sign is a page cut from *Radio Retailing* headed: "Why Good Servicemen Charge for Inspection."

To make certain that time will not later be lost in argument, I also tell the customer when I take a set that if the repairs required are not ordered from me there will be a charge. I seldom need elaborate. Ninety-five percent of my customers seem to be fair, reasonable people who do not want something for nothing.

Explain, Politely But Firmly

Sometimes, it is true, a customer will say: "What! You charge for not repairing the radio?"

I give such customers a talk along these lines: "Often it takes more time and equipment to find trouble than it does to fix it. It costs me money to operate, as you can see from the expensive equipment I

No CINCH



The first one with an explanation that it follows only the most necessary repairs and that a few other parts, etc. are weak and could be better replaced, even rather than a few months from now. And they're right, too.

More of us don't really have spare change, tho, and we get a good pretty hard for the radio. The psychological effect of my estimate, at probably the same price from my different radio, etc.

CONSUMER CONFIDENCE is a name we need more to show a man that a radio repair estimate from me is the best one he can get.

At the end of the article for a copy of the "Code" system, please send me a stamped return address.

I have not don't need it, but I've shown around with just next to nothing to the local shop. I know how they can't afford to do it, but I'll be glad to do it for you if you get made the able of one of these.

They're Not The Best - I have not don't need it, but I've shown around with just next to nothing to the local shop. I know how they can't afford to do it, but I'll be glad to do it for you if you get made the able of one of these.

When you get a radio, you should know what you're getting. I have not don't need it, but I've shown around with just next to nothing to the local shop. I know how they can't afford to do it, but I'll be glad to do it for you if you get made the able of one of these.

Of course, you're going to get a radio that's not the best. I have not don't need it, but I've shown around with just next to nothing to the local shop. I know how they can't afford to do it, but I'll be glad to do it for you if you get made the able of one of these.

And now to the point of the article. I have not don't need it, but I've shown around with just next to nothing to the local shop. I know how they can't afford to do it, but I'll be glad to do it for you if you get made the able of one of these.

FINDING TROUBLE frequently takes as much time as fixing it. So you might better let a man walk out than do half his job for nothing

How to Make

INSPECTION CHARGES

Stick

buy and keep up to date. No man can work even finding trouble without pay and remain in business. You will find that all reliable servicemen charge for inspection. They must."

If they still object, I tell them politely and gently: "If you do not care to leave the set with me on those terms you may take it with you and I shall not be offended. I could not find the trouble while you waited, anyway, because I give all jobs an order number and pursue a policy of 'first come, first served.'"

Don't Let Them Kid You

Don't ever allow a customer to talk you into taking a set on a free

"Seller's Market" SUGGESTION

SOME SERVICEMEN like the cooperative method of outwitting chisellers outlined in our May issue. Others think there are more straightforward ways. But all agree that this is the time to somehow stiffen up estimating policies

estimate and you won't have to use the system recommended by the man who wrote that story in May. Do not worry if you lose customers who insist on free estimates. It is generally profitless anyway and you will probably earn more money if you get rid of it.

Of course, I must confess that I have not always charged for inspection. Years ago, before I learned from cruel experience, I lost a good deal of money working the other way.

Customers would bring radios in. I would frequently get "stickers," work all afternoon on them. When the customer was given an estimate he would say: "Oh, that's much more than I thought it would cost. I can't afford to pay that. Thank you . . . goodbye."

Sometimes I would not even get the "thank you."

"Goodwill" Value Questionable

I soon began to see that there were many more profitable things I could be doing with my time, particularly since many of the sets I inspected for nothing were miserable

junk-piles that people could scarcely be blamed for refusing to have them repaired for more than a very moderate sum.

When I got a cost-accounting system going I saw even more clearly that I had to charge for inspection. I found out what it cost me to just keep open for an hour.

No more finding trouble for nothing for me!



Likes "Code" System

I have read and re-read the article on "Service Estimating" in the May issue and it sure is the greatest idea for servicemen I have ever seen in print.

No sane serviceman who sees what has previously been quoted is going to cut the price since the first man may not even have found every trouble.

It gives the second man the job for sure, because the customer just will not go any further when he is confirmed on the price. He wouldn't return to the first man anyway. This gives us a chance to "ease up" on the estimate. The idea is like a fraternity password.

Please try to get every serviceman interested. This idea could do more to elevate the radio service business to a higher plane than anything else I know about.

LINDEN, N. Y.

R. MALLISON
Mallison Radio Service

Will There Be a *Shortage* of SERVICEMEN?

FOR THE FIRST TIME in the history of radio servicing there is today a very real threat of a trained technician shortage.

With the defense program barely under way, men are already leaving the field in appreciable numbers to work in factories where they command substantially larger salaries. This is particularly noted in industrial cities located on both coasts, will probably soon make itself felt at inland points now increasing production of military materials.

Part-Timers Go First

One northeastern parts jobber advises that analysis of accounts on his books in January 1940 indicates that 58 per cent were part-time operators. Checked again in January 1941, part-timers represented 55 per cent, the ratio falling despite the fact that the total number of active accounts rose 3 per cent during the year. In May 1941 part-timers represented 52 per cent of the total number of concern's sold and that total had dropped 10 per cent.

Decrease in the total number of accounts (particularly in the ranks of part-timers) can, in the estimation of many, prove a blessing in disguise for those technicians remaining in the field. With less competition, it is argued that this is the time for them to increase charges to a figure commensurate with operating costs, investment in equipment, rising cost of replacement parts. Consumer demand for service, reported equalling past seasons, seems to make such a move practical.

One opinion widely encountered



IN THE ARMY NOW—Some technicians are already in uniform. Others are shifting to defense industries

is the probability that dealers employing servicemen will have to grant wage increases to hold men tempted by more lucrative defense work as the cost of living rises.

Transition Period Hints

Among parts jobbers, the decline in the number of saleable accounts is causing some concern but most jobbers believe that business lost in this manner will be compensated for by strengthening of servicemen remaining in the field, sharing of the same amount of consumer business among these accounts at more profitable levels. Consumer demands for service, many contend, must increase as material for the

production of new equipment becomes harder to obtain and more expensive.

A number of jobbers contacted appear to be quietly tightening credit requirements among the smaller shops, particularly those operated by one man whose shift to a defense industry or the army would cripple the operation if not curtail its activities entirely. (Still closer checkups are noted among concerns distributing on a consignment basis.)

Draftees and technicians enlisting in military services are granted a moratorium on indebtedness for the period of service. This freezing of debts is causing some tieup of jobber funds and a number of methods of liquidating, considered equitable to both parties, are encountered in the field. One such plan involves return to the jobber of merchandise purchased by the serviceman (in clean and resaleable condition) at 10 per cent reduction from net cost. If such returns amount to more than current indebtedness credits are later to be issued for the purchase of new stock, at the termination of military service.

From One PARTS JOBBER's Records . . .

	Full Time Accounts	Part Time Accounts	Total
January 1940	172	240	412
January 1941	193	232	425
May 1941	178	194	372*

* 41 went to work in factories, 12 left for military service

Only **PHILCO**
gives you these new, exclusive
phonograph features

TO SELL!

- ★ MUSIC ON A BEAM OF LIGHT!
- ★ PHILCO AUTOMATIC RECORD CHANGER!
- ★ STROBOSCOPE PITCH AND TEMPO CONTROL!
- ★ AMAZING IMPROVEMENTS IN HOME RECORDING!
- ★ BRAND NEW 1942 TILT-FRONT CABINET!
- ★ EXCLUSIVE PHILCO FM SYSTEM!

Only Philco has it!



PHILCO 1013
RADIO-PHONOGRAPH

1942... Another Year of **LEADERSHIP!**

More than ever before, Philco for 1942 gives you the only *modern* radio-phonograph to sell! These exclusive Philco inventions are the features the public *demand*s today in a phonograph... and they are yours to offer *only* in a *Philco*.

The greatest buying enthusiasm in Philco history greeted the 1942 Philco line. The greatest advertising campaign in Philco history is backing it. Another sensational year of profits is ahead for Philco dealers!

**SEE YOUR PHILCO
DISTRIBUTOR NOW**

PHILCO ALL YEAR 'ROUND

The Most Valuable Franchise
in the Appliance Field!

Do

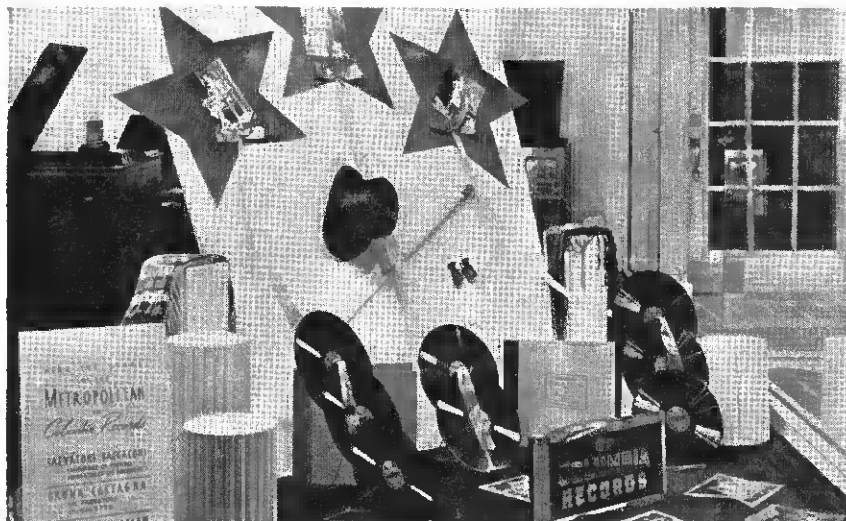

HI-HAT WINDOW—A silk topper, white gloves and opera glasses, mounted on a large square of fluted white paper, points up a display of classic Columbia records for Whittle Music of Dallas

IDEAS Under Glass



ALL THIS AND MORE—Spear's of New York dramatizes things radio brings into a home by means of simple, black action silhouettes glued to a neutral set display board (below).

SEEING STARS SELLS — Photographs of famous Warner Brothers picture people using RCA personal portables, mounted on cards backing up several actual sets did a display job



TIME PAYMENT profits can be augmented if you have the courage and can find the cash to swing it

HIGH INTEREST and carrying charges tacked on car radios by auto finance firms when they first went after such business some years ago made many purchasers mad.

This situation gave an Illinois dealer an idea. He would finance all good credit risks himself when the customer bought a car or a home radio at his store.

"That's how we got started financing our own sales," explains Art Hoffman, owner of the firm bearing his name at 1908 State Street, East St. Louis, handling Philco, Motorola, RCA Victor, and Zenith.

Profitable Part of Business

"Today, our financing operation is a profitable part of the business," says Hoffman. "We started out in a modest way, putting aside a surplus for this purpose. The way we look at the finance problem is this: If a finance company considers our customers safe credit risks then why shouldn't we?"

"We were paying a 10% discount and agreeing to recourse terms when we turned over customer's paper. If a customer fell down on his pay-

You FINANCE

Your Own Paper?

DEALER HOFFMAN—His experience over a ten-year period makes very interesting reading

ments the only thing saved by us was the collection expense."

Cash Needed to Swing

Asked how much money a dealer needs for financing all business Hoffman commented: "Assuming that annual installment sales are \$24,000, \$2,000 a month, a radio retailer needs not less than \$6,000 for six months' operations. But, when he uses up his own reserve, he can still send the remainder of his deferred payment business through a commercial finance firm.

"Of course, we also keep a reserve

Sell DOWN If Necessary

DELINQUENT ACCOUNTS frequently indicate that the customer was sold more merchandise than he could chew in the first place



for overhead expenses and for trade-in allowances.

Safe Maximum Terms

"Our policy on radio installments is to avoid in every possible way stringing out payments over extreme periods. We find that many people are inclined to get careless in paying their radio accounts when these run over ten months. We try to limit terms to 8 months. On car radios 6 months covers our usual contract.

"We fix the amount of monthly payments at a figure which we are reasonably convinced a customer can pay, selling smaller sets if necessary. We try to have payments fall due on the customer's pay day. Our carrying charge rate is 6% on radios. (7½% on refrigerators).

"Today we include carrying charges along with installation and

By
HOWARD BARMAN

aerial costs in our quoted price for a car radio. We don't quote the list but lump everything into one price. To this day car owners haven't forgotten high carrying charges of the past. When you begin to quote extras they get impatient.

Good Collection Experience

"Our collection experience has been good. We are careful to whom we sell.

"We do not have to send anyone out on collection jobs more than once in three weeks or more.

"Customers like the idea of paying accounts at the store. If there is illness, or temporary lay-off at a shop or factory, they feel better asking for an extension in person. We tell them, 'You can pay here just as you would at your furniture store.'

"When a man or woman stops in to make a monthly payment it also gives us a chance to sell an auto radio to a home radio customer, or the other way around. Arranging installment payments in our store is thus an advantage to customers and an advantage to us.

"You can be sure we do not engage in \$1 down and \$1 a week business. That would be fatal."

THESE NEW RCA

LED BY HOLLYWOOD ARE MORE THAN HOT

Jammed with super-sales features . . . sparkling with fresh, modern beauty . . . these great new sets deserve preferred position on your sales floor.

★ RCA VICTOR HOLLYWOOD RADIO with the great sales "extra" of not one —but TWO SPEAKERS

Here's a radio so hot it sizzles! And these sensational sales features prove it. It has two speakers—which "floodlight" tone so that no matter where the listener sits in the room he may enjoy full, rich reproduction of his favorite programs . . . New "studio" controls for tuning convenience . . . 9 RCA Victor Preferred Type Tubes . . . Push-button electric tuning . . . 2 built-in antennas . . . Overseas Dial . . . Spread-band tuning on 31, 25 and 19 meter shortwave bands . . . and a host of other equally great "extras."
Model 29K-2

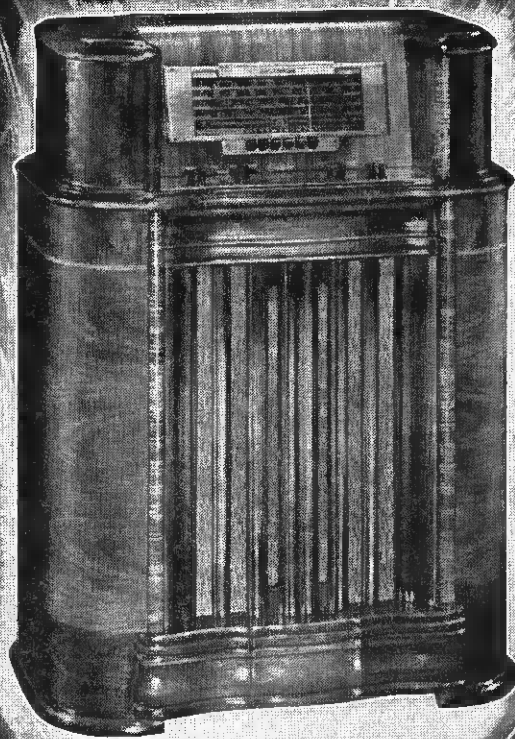
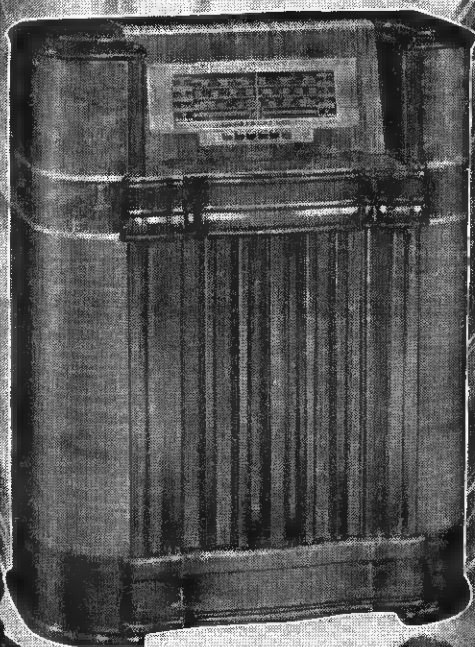
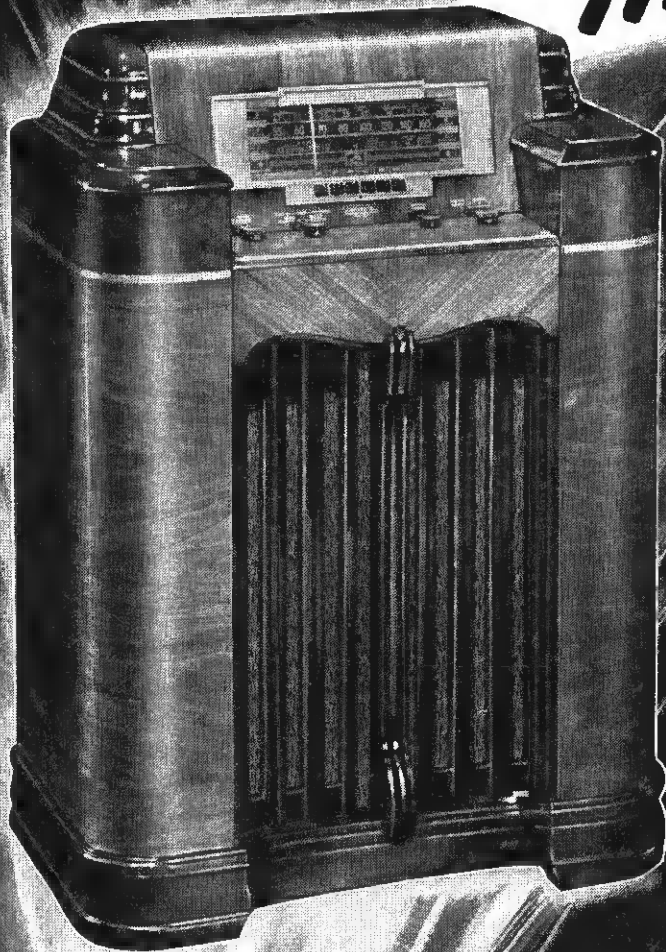

★ **RCA VICTOR Model 211K**
(at right) Features 2 speakers . . . new "studio" controls . . . 11 RCA Victor Preferred Type Tubes . . . stage of tuned r-f amplification . . . 2 built-in antennas . . . Overseas Dial . . . Super-spread band . . . Push-button electric tuning, and many other features.

★ **RCA VICTOR Model 29K**
(at left) Here's a value from the word "go"! 9 RCA Victor Preferred Type Tubes . . . American and improved foreign reception . . . 2 built-in antennas . . . Push-button electric tuning . . . Overseas Dial . . . Spread-band tuning . . . New "studio" controls . . . other features.

A Service of the Radio Corporation of America. In Canada, RCA Victor Co., Ltd., Montreal. Trademarks "RCA Victor" and "Victrola" Reg. U. S. Pat. Off. by RCA Mfg. Co., Inc.



VICTOR VALUE-LEADERS

TWO-SPEAKER MODELS

...THEY'RE **TORRID!**

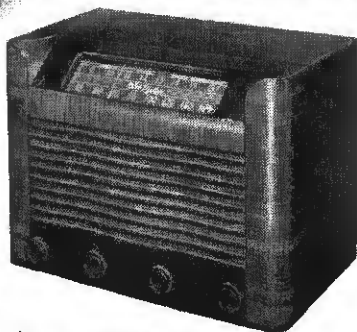

★ **RCA VICTOR Super-Eight (Model 28X)**—Super-tone with 9 1/4" Ellipticon Speaker . . . 8 RCA Victor Preferred Type Tubes . . . Overseas Dial with Spread-band tuning . . . American and foreign reception . . . 2 built-in antennas . . . AC-DC operation.

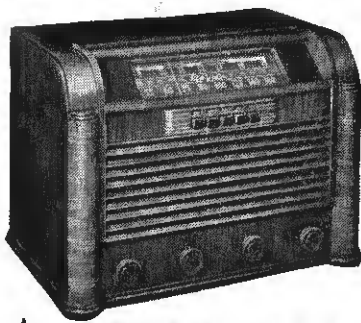

★ **RCA VICTOR De Luxe Super-Eight (Model 28X-5)**—This super-set is packed with super-features that will thrill your customers. Embodies all the features of the Super-Eight plus Automatic Electric Tuning (5 stations) . . . AC-DC operation.

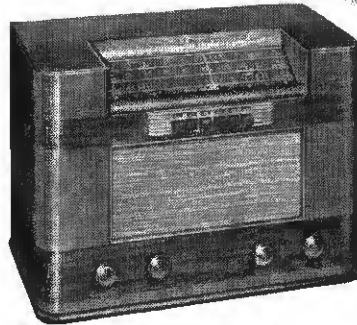

★ **RCA VICTOR Model 28T**
A winner in any company! 8 RCA Victor Preferred Type Tubes . . . 9 1/4" Ellipticon Speaker . . . 3-band Overseas Dial with Spread-band tuning . . . Electric Tuning (6 stations) . . . 2 built-in antennas . . . and many other features.

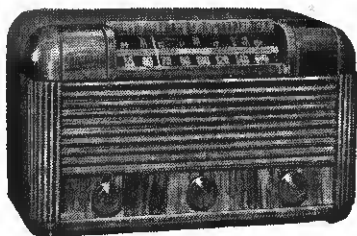

★ **RCA VICTOR Model 26X-3**
Its superb features and sensational low price will bring you many orders. 6 RCA Victor Preferred Type Tubes, providing 8-tube performance . . . 2-band Overseas Dial with Spread-band tuning . . . AC-DC operation, and many others.

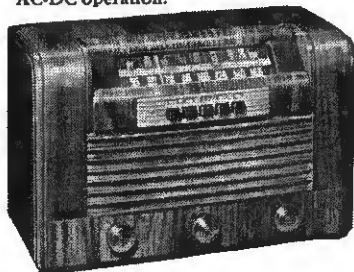

★ **RCA VICTOR Model 26X-4**
Here's a set that will virtually sell itself! 6 RCA Victor Preferred Type Tubes (8-tube performance) . . . 2-band Overseas Dial with Spread-band tuning . . . Electric Tuning (5 stations) . . . 2 built-in antennas . . . AC-DC.

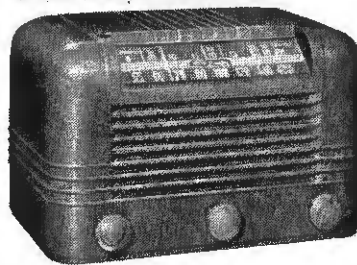

★ **RCA VICTOR Model 26X-1**
Packs a sales wallop with 6 RCA Victor Preferred Type Tubes (8-tube performance) . . . 2-band Overseas Dial with Spread-band tuning . . . American and improved foreign reception . . . built-in Magic Loop antenna . . . AC-DC.

SUMMER SPECIALS WITH SALES-SOCK!

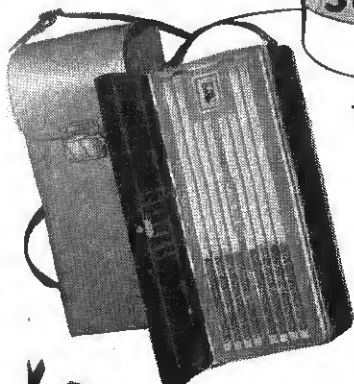

★ **RCA Victor Personal Radio Model BP-10 with Carrying Case**

a \$26.50 value your customers will go for at \$20! Genuine leather carrying case free with purchase of easy-to-carry radio which weighs only 4 1/4 lbs. Has four RCA Victor Tynetron Tubes (6-tube performance) . . . Ellipticon Speaker . . . built-in antenna.

★ **RCA Victor Three-Way "Pick-Me-Up" Model 25BP**

is a splendid all-purpose set. Operates on batteries or AC-DC . . . 5 RCA Victor Preferred Type Tubes . . . Permanent magnet dynamic speaker . . . built-in Magic Loop antenna . . . easy-reading, clock type dial . . . finished in durable, two-tone tan leatherette.

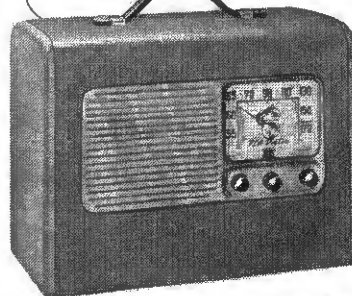

SOUND for 125,000

HUTCHINSON, Kansas, was literally "blasted" loose from its foundation during a recent three-day "Prairie Powwow" held in celebration of the city's 70th birthday.

Earl K. Rounkles of Rounkles Radio Service supplied all the "super-sound" necessary to cover Chamber of Commerce-sponsored events, over 2000 in number. There were 125,000 participants, many of whom journeyed from miles around to attend.

High Power

Rounkles servicemen lugged portable amplifiers, record players, microphones and loudspeakers for three solid days—beginning Thursday, April 24th at 7:00 a. m., winding up work Saturday at 10:00 p. m.

The largest unit used was a 100 watt amplifier equipped with three mike and one phono inputs. Earl used dynamic mikes, a. c. generators, and weatherproof projectors. The speakers selected for the main, central setup were three Atlas

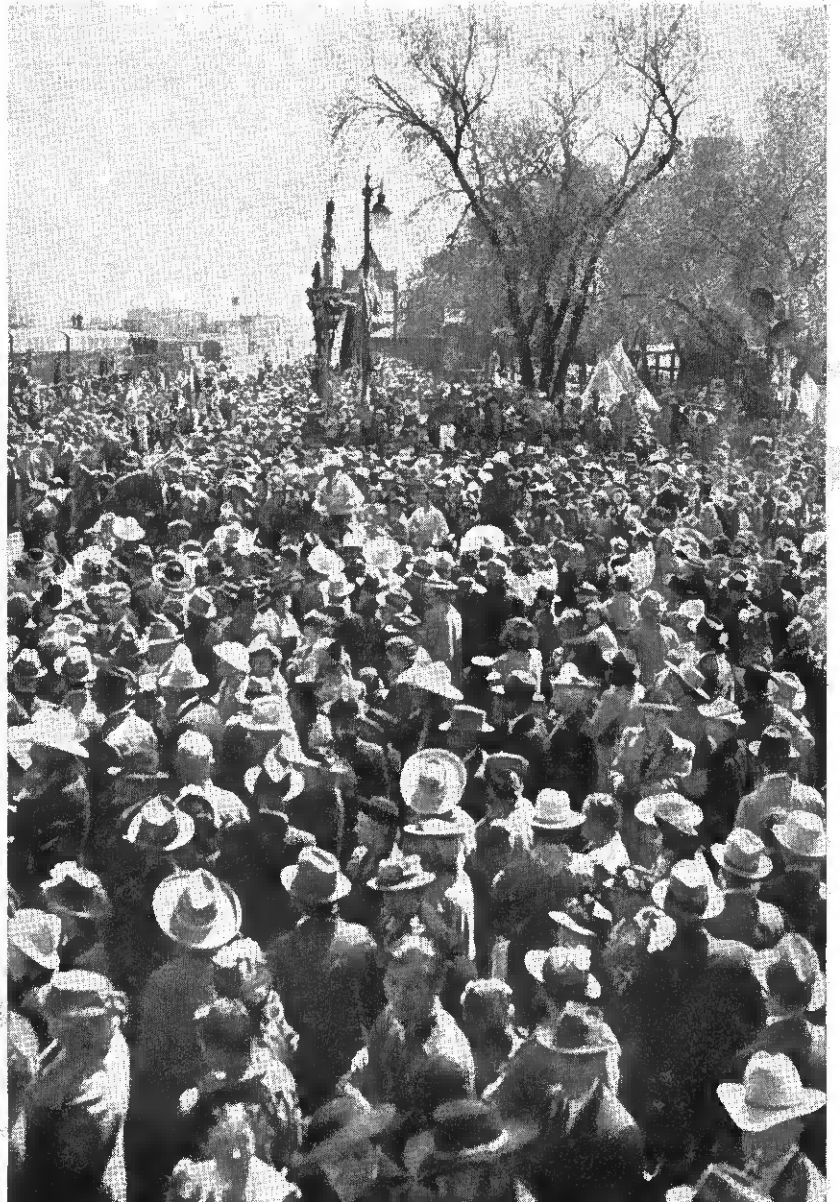

CENTRAL SETUP—A 100-watt amplifier into 3 speakers gave 360-degree coverage



Sound DR-72 Dynamic Reflex Projectors of the six foot air column size, driven with PM-26 Dyna-Flux P. M. Compressor Units.

Rounkles reports that the Chamber of Commerce was overjoyed with the coverage and quality obtained. It will be noted from the picture that the speakers were mounted on a single pole, arranged to give 360° coverage.

Low-Power

Rounkles was prepared for all eventualities. Extremely compact and portable projectors were used at such events as the Santa Fe Exposition, which included unveiling of a new streamlined "Jeep" freight locomotive among additional railway equipment worth more than \$2,000,000.

Sound was in there pitching at the "Nightly Street Dances"; the

"Pet and Hobby" and "Youth Parades"; at the "Early West" show; the ridin' and ropin' events; the "Old Fiddlers" contest; the flag ceremonies.

This energetic sound man has covered many similar big time rentals such as the recent "Cornodo Fiesta" staged in Lyon, Kansas, which had participants from all 48 states and several Central American countries.

"PRAIRIE POWWOW"

**HOW Rounkles Radio
handled 2,000 outdoor
events in 3 days**

RCA Laboratories

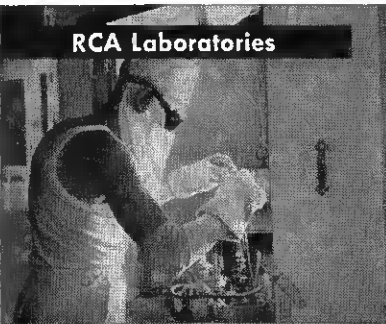

RCA Manufacturing Co., Inc.



National Broadcasting Company, Inc.



Radiomarine Corporation of America

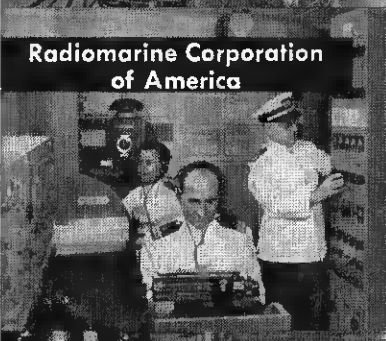

RCA Institutes, Inc.



R.C.A. Communications, Inc.



Among the many ideas of the famous Florentine artist and scientist, Leonardo Da Vinci, were: a flying machine, parachute, air-conditioning ventilator, sea-diving apparatus, printing press, mechanically driven car, machine-gun, breech-loading cannon, sbrapnel, aerial bombs, lens grinder and polisher, nap-raising machine.



WHAT MAN CAN IMAGINE

Research can Achieve!

ABOUT the time Columbus discovered America, many of the wonders of our Mechanical Age lived as ideas in the mind of Leonardo Da Vinci. When he died, he left behind him some 7,000 sheets of drawings and notes depicting scores of "inventions." But Da Vinci's imagination wasn't enough to give life to his shadowy visions. That's why, could he return to earth today, he would be gratified to learn that what man can imagine, research now can achieve.

Thanks to research, RCA has created a dependable, world-wide radio communications service operating across the hemispheres to 47 countries. As a result, the United States is now the communications center of the world.

Thanks to research, RCA provides millions with radios, vacuum tubes and RCA Victrolas; builds transmitters and other broadcast equipment for radio stations from coast to coast. In modern design, efficiency and usefulness, these products are second to none.

Thanks to research, scores of ships go to sea equipped with RCA marine radio apparatus, which guards life and property on the waterways of the world. Afloat as ashore, the slogan "RCA All the Way" is a guarantee that messages will be delivered with speed and accuracy.

Thanks to research, RCA makes possible, through the National Broadcasting Company, the best in entertainment, in up-to-the-minute news, and in education, giving America and Americans the finest and most worthwhile radio programs in the world.

Thanks to research, RCA is a mark of progress and service in the public interest. And in RCA Laboratories, research today is testing for the future —so that in years to come more millions may enjoy a richer, fuller, more satisfying life.



RCA LABORATORIES

A Service of the Radio Corporation of America
RADIO CITY, NEW YORK, N. Y.

Other RCA Services: RCA MANUFACTURING COMPANY, INC. • RADIOMARINE CORPORATION OF AMERICA • NATIONAL BROADCASTING COMPANY, INC. R.C.A. COMMUNICATIONS, INC. • RCA INSTITUTES, INC.

Comparative BATTERY Types

TRADE NAME	1.5 v.	1.5 v.	1.5 v.	1.5 v.	1.5 v.	1.5 v.	4.5 v.
Acme.....	114	116	118	118FM	123M	123
Advance.....	247	147	547	647
Bond.....	4826	4824	4829	4823	4828	4928
Bright Star.....	462	660	860	865	20-60	465	361
Burgess.....	4F	6F	8F	8FL	20F	4FL	G3
Eveready.....	742	743	741	745	740	746
Gamble.....	1966
General.....	4F1	6F1	8F1	8CF1	12L1L	3L1	3H3
Marathon.....	491	691	891
National Union...	A830	A831	A833	A832
Philco.....	P94	P8F1	P100
Ray-O-Vac.....	P94A	P96A	P98A	P98L	P9203	P94L	P83A
Sears.....	5089	5087	5077	5160	5085
Usalite.....	634	637	635	645	642	683
Wards.....	5021	5005	5020	5016	504z
Western.....	D234
Willard.....	4F1	6F1	8F1	8CF1	3L1	3H3
Winchester.....	4816	4814	4819	4813	4818	4918

TRADE NAME	6 v.	6 v.	6 v.	7.5 v.	45 v.	45 v.	45 v.
Acme.....	118S	118S6	430	330	830
Advance.....	817	747	2476	237	267	284
Bond.....	4827	4825	3017	6220
Bright Star.....	866	868	646	561	3055	3003	3033
Burgess.....	2F4	2F4L	F4P1	G5	Z30	B30	M30
Eveready.....	718	747	738	762	482
Gamble.....	5130
General.....	8F4	8CF4	4F4	5H5	V30A	V30B	W30B
Marathon.....	340	350
National Union...	A834	B860	B861
Philco.....	P305	P200
Ray-O-Vac.....	P698A	P698L	P694A	P85A	P7R30	P5303	P5S30
Sears.....	5086	5078	5090	5079
Usalite.....	638	646	639	687	620	624	640
Wards.....	5006	5008	4949	4952
Western.....	D214	D213
Willard.....	8F4	8CF4	4F4	5H5	V30A	V30B	W30B
Winchester.....	4817	4815	6218	6210

New



RCA SOUND SYSTEM for use in mobile, portable, or permanent installations. Operates from 105-125 volt, 60 cycle power or from a 6 volt battery. Delivers 15 watt output and is available with or without the turntable and pick-up. Measures 16½ long, 12 deep, and 12 inches high. RCA Mfg. Co., Camden, N. J.

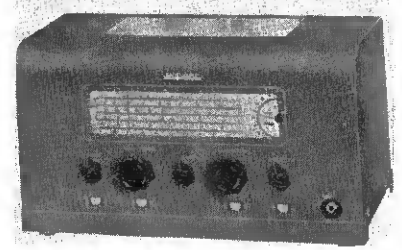

HOWARD AC-DC COMMUNICATION RECEIVER can be operated from 105-117, 120-150, and 210-240 volts. Uses 6 latest type tubes. Has 3-gang tuning condenser. Tunes from 540 kc to 43 mc (556 to 7 meters) on four overlapping bands with band spread on all bands. Howard Radio Co., 1735 Belmont Ave., Chicago, Ill.

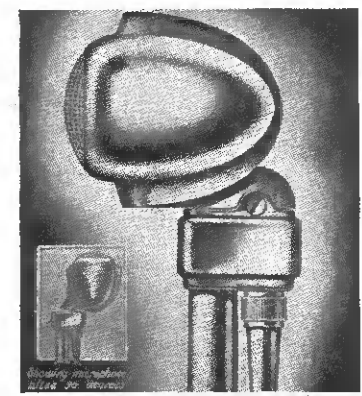

STROMBERG-CARLSON MICROPHONE, #7 dynamic type, is streamlined with satin-chrome finish. May be tilted to 90 degrees for non-directional operation. Available with or without "Off" and "On" switch. Output level, minus 54 db. frequency response, 40-8000 cycles; weight packed, 3 lbs., diameter, 2 7/16 inches. Stromberg-Carlson Tel. Mfg. Co., 100 Carlson Road, Rochester, New York.

Products . . .

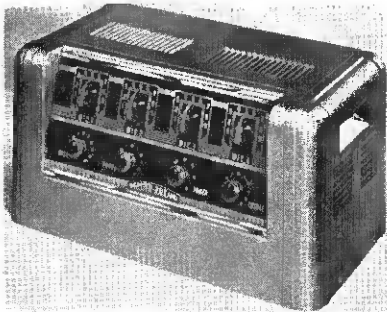

WEBSTER-RAULAND BI-POWER AMPLIFIER with 60 watt power output has 4 microphone inputs, 2 phono inputs with dual fader. Equipped with separate base and treble tone controls, and remote mixing of 3 microphones. Webster-Chicago Sound Div. of The Rauland Corp., 3825 Armitage Ave., Chicago, Ill.

UNIVERSITY SPEAKER, model 1BR, radial intercommunicator booster type is designed where efficiency and compact size is required and is mounted vertically in the center of the area to be covered. Bell diameter is 8 inches. Comes complete with built in PM driver unit with 10 watts power capacity; impedance 8 ohms. University Laboratories, 195 Chrystie Street, New York, N. Y.

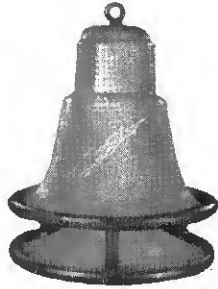

TRIPLET VOLT-OHM-MILLIAMMETER with 12 ac and dc voltage, ranges to 5000 volts (dc at 10,000 ohms per volt). Checked for 11,000 volts breakdown. New cartridge battery loading feature permits replacing batteries by removing snap-on cap and dropping them in the compartment. No soldering; no wiring; no need to open the tester. Model 625-T. Dealer's net price, \$22.00. The Triplet Electrical Instrument Co., Bluffton, Ohio.

HALLICRAFTERS SOUND SYSTEM, model RSC-2, includes FM-AM tuner, 25-watt amplifier and monitor speaker, all inclosed in single rack of table-mounting type. The tuner provides AM reception throughout the range of 540 to 1650 kc. and FM in the range of 40 to 51 mc. Both the FM-AM tuner and the S-31A amplifier are available separately. Halli-crafters, Inc., 2611 S. Indiana Ave., Chicago, Ill.

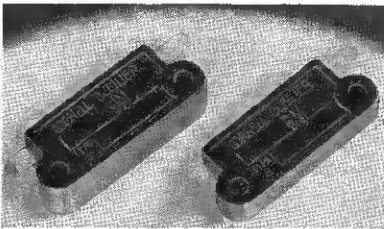

CORNELL DUBILIER MIDGET MICA CAPACITORS, moulded in brown bakelite, have an overall size of $1\frac{1}{8} \times \frac{5}{8}$ inches with thickness varying from .25 to .4 inch. Type B unit illustrated. Standard units are available in capacities from .000,001 mfd. to .01 mfd. Those up to .003 mfd. carry dc operating voltage ratings of 500; above this value the rating is 300 volts. Type B is also available in low-loss yellow bakelite, supplied on special order. Cornell Dubilier Electric Corp., South Plainfield, N. J.

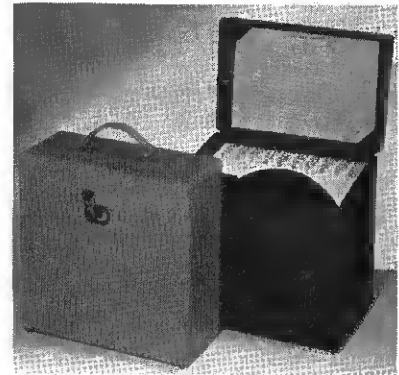

FREDERICK KUGEL A new kind of record file for home or portable use with indexed envelopes for each record. Both available in genuine leather or simulated rawhide, saddle tan, redwood, or suntan. Frederick Kugel Company, 1233 Sixth Ave., New York, N. Y.

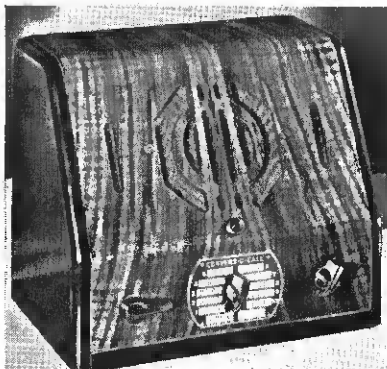

NATIONAL INTER-COMMUNICATING SYSTEM, model 400, allows conversation between 1 to 10 people at one time or individually. A two-way voice-link at any distance up to 15,840 ft. "Convers-O-Call" operates on 110-125 volt ac-dc current. Can also be used as a public address or paging system. Housed in finished walnut cabinet. National Inter-Communicating Systems, 2434 Montrose Ave., Chicago, Ill.

UNITED CINEPHONE SUN-SWITCH is used to control electrical circuits in accordance with light conditions. The user chooses the two lighting levels at which he wishes the load switched on and off, and then adjusts calibrated dials to the corresponding foot candle readings. Operation is automatic, no re-setting being necessary. Uses a type 921 phototube, having life expectancy of 20,000 hrs., and two type 6J5 tubes. Operates from 110 volts, 50 or 60 cycles, ac. List price \$28.50. United Cine-phone Corp., Torrington, Conn.

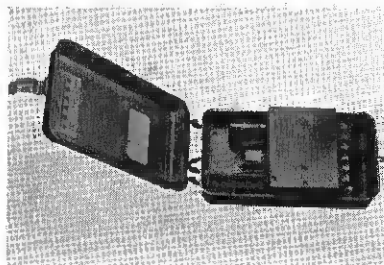

SEA PAL PORTABLE RADIO and direction finder receives weather reports and beacon stations, 190 to 410 kc., and broadcast stations from 535 to 1600 kc. Operates on ac-dc or battery. Rotating loop contained in the front cover can be unfastened and plugged into the top of radio where a compass scale indicates direction. Contains 5-inch speaker and provides jacks for headphones. Sea Pal Radio Co., 228 N. La Salle St., Chicago, Ill.

SNOOPER'S PARADISE!



Everything's hunky-dory for our hero, Homer G. Snoopshaw, B.R.S. (Battery Replacement Specialist), since he went to work in the Burgess Battery Company's own replacement laboratory. With his uncanny knowledge of radio batteries he can specify the necessary replacement at a glance — hasn't been stumped yet!

Of course, the fact that he keeps a "Burgess Replacement Guide to Portable Radios" in his pocket may have something to do with his brilliance. In fact, we know plenty of dealers who depend on the "Guide" for bigger, quicker replacement sales every single day! Included is the new "Quick Reference Price List"—covers the complete line at a glance!

Got your free copy yet? See your distributor, or write to Homer G. Snoopshaw, B.R.S., care of Burgess Battery Company, Freeport, Illinois.



Homer recommends

Burgess No. 4GA42 for several portables notably Philco 40-81, 40-82, and 40-PT-63. Another unit that makes Burgess "The Complete Replacement Line."

BURGESS BATTERY CO.
FREEPORT, ILLINOIS

BURGESS THE *Complete* REPLACEMENT LINE

YOU'VE GOT A SURE SALE WHEN YOU SHOW THEM THE } **NEW PRESTO, JR. TURNTABLE**



● Radically different in design and performance from any other turntable on the market . . . excellent for playing sound effects, phonograph records or 16" electrical transcriptions. A 12" dual-speed table that matches closely the performance of a 16" table at *one-fourth the cost*. It's precision-machined, dynamically balanced, hand-finished throughout . . . powerful, vibrationless. Speed is accurate to .4%, regulation within a revolution .2%. Show it to your customers who want a *better* turntable. Write for catalog sheet and price.

Canadian Distributor: Walter P. Downs, 2313 St. Catherine St. W., Montreal, P. Q.

PRESTO RECORDING CORPORATION
242 West 55th Street, New York, N. Y.

World's Largest Manufacturers of Instantaneous Sound Recording Equipment and Discs

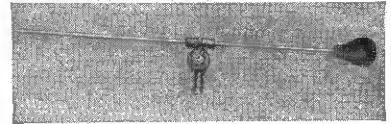

ATLAS EXTENSION ARM, "Baby Boom", can be easily attached to any microphone stand. Permits a quick and fixed positioning of the mike anywhere within a six-foot diameter circle. The tube section of this model BB-1 extension is 32 inches long and the microphone thread size is 1/8 inch—27 for all standard microphones and stands. List price \$7.50. Atlas Sound Corp., 1443 Thirty-Ninth St., Brooklyn, N. Y.

DUOTONE NEW CHROMIUM NEEDLE, claimed to be good for at least 50 playings, is placed on the market by this company. The needle is issued in handy folding packages of five. Highly polished for smooth, even tone and minimum record wear and individually shadowgraphed for flaw detection. Duotone Co., Inc., 799 Broadway, New York, N. Y.

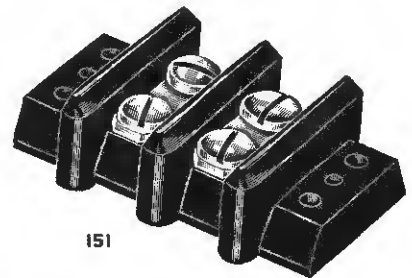

HOWARD B. JONES BARRIER TERMINAL STRIPS, No. 150 series, are compact with maximum metal-to-metal spacing to prevent direct shorts from frayed wires at the terminals; and are made of heavy molded bakelite. 3 sizes: No. 150 have 10-32 screws, with 5/8 inch metal-to-metal spacing; 151 have 12-32 screws, with 3/4 inch metal-to-metal spacing; and 152 have 1/4 inch-28 screws, with 1 inch metal-to-metal spacing. Howard B. Jones, 2300 Wabansia Ave., Chicago, Ill.

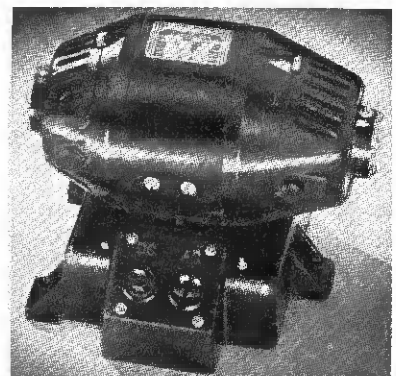

EICOR COMPACT MODERN CONVERTER is convenient for portable or permanent use. Converts direct current to alternating current. Available for 5, 12, 32, 115, 230 volts or other ac output. All-equipped with ball bearings. Available with or without filter. Eicor, 1060 W. Adams St., Chicago, Ill.

PRESTO TWO NEW DISCS introduced by this company. One, a glass base disc which is smoother, flatter, and thicker than metal base discs. The other, a steel base disc, made in 6, 7, 8, 10, 12 and 16-inch sizes. Presto Recording Corp., 242 West 55 Street, New York City.

KURMAN SENSITIVE POWER RELAY with volt-meter accuracy from -24 to +99 degrees centigrade is announced by this company. Has moulded base and silver contacts. Operates on .0018 watts. Claimed to give perfect performance despite vibration or temperature changes. Model BK25. Kurman Electric Co., 241 Lafayette St., New York, N. Y.

as well as swinging the dipple flatwise. Technical Appliance Corp., 17 East 16 St., New York, N. Y.

GALE PORTABLE AIR CONDITIONING UNIT, "Lake Louise" model C-50, has a deluxe streamlined, wood-grained cabinet. Claims a capacity of 6100 B.T.U. This window type unit (illustrated) provides for filtering, dehumidifying, cooling, and circulating the air. List price \$199.50. Also available is the slightly smaller, 4700 B.T.U. "Lake Placid" model with gunmetal finish cabinet. List price \$149.50. Gale Products, Galesburg, Illinois.

RCA NEW 16-INCH DISC introduced by this company is a fire-resistant, paper-core recording blank used where sound is recorded for reference purposes. This blank is thinner and lighter and is sold for one-half the price of aluminum-core blanks. RCA Mfg. Co., Camden, N. J.

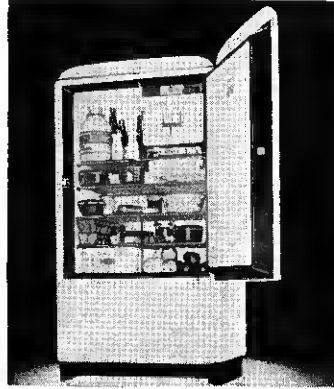
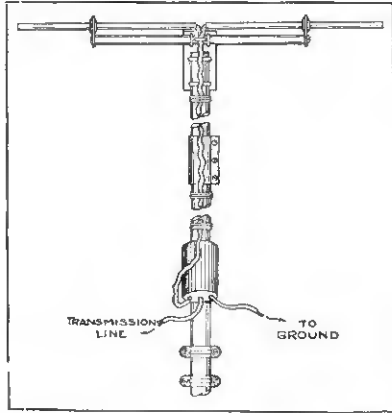
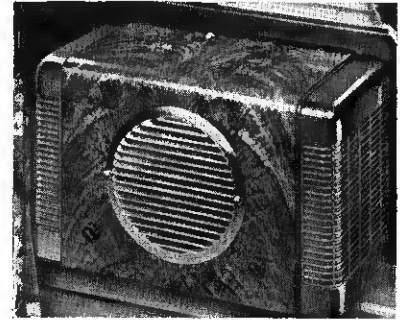

TACO COMBINATION ANTENNA SYSTEM for FM, AM, short-wave, and television which starts with a dipole comprising two metal rods held by a center bracket mounted atop a mast. The two rods connect with the antenna transformer mounted on the mast, which in turn feeds into the transmission line. A bracket holding the dipole to the mast permits tilting the dipole at any angle from horizontal to vertical,

HOTPOINT REFRIGERATOR, model EB8-41, the Standard Tudor is a roomy 8.2 cu.ft. box. Has large capacity speed freezer, pop-ice trays holding 80 cubes, sliding vegetable drawer and special compartment to keep meats fresh. Contains one stationary shelf and three split shelves. Edison General Elec. Appliance Co., Inc., 5600 Taylor St., Chicago, Ill.

MIRROR TWO-SIDED RECORD BLANKS in sizes 8 to 16 inches are scientifically coated on a tough, light-weight fibrous base. Prices are in lots of 25: 8-inch, \$.14; 10-inch, \$.21; 12-inch, \$.30; and 16-inch, \$.60. Mirror Record Corp., 58 West 25 St., New York City.

RECOTON CONCERTO, a new louder tone "Phoneedle," is introduced by this company. Designed to meet the need for a high volume pitch needle. Made of the same steel alloy used by this company in all its "Phoneedles." Recoton Corp., 42 West 15 St., New York, N. Y.

NOW THAT TELEVISION HAS "GONE COMMERCIAL" DU MONT IS READY

Within the limitations set up by the demands of the United States defense effort, this Company is ready to meet all needs for Television equipment. This includes the latest, most modern types of Television

transmitters and a complete line of Television receivers.

Tell us your supply problems and we will do our best to help you solve them.

Du Mont

PIONEER IN TELEVISION

ALLEN B. DU MONT LABORATORIES, INC.
PASSAIC • NEW JERSEY

INSIDE Stuff

PROPAGANDA is a word many of us are learning to dislike. Yet there are "white" as well as "black" causes to which it may be harnessed. Take radio's present raw material predicament, for example. We're not begging special favors from the government during its present all-out defense drive but we do sincerely believe that radio is one of the most potent weapons for getting the public behind this effort and keeping it there the nation has. And that upward revision of the B7 priority rating now classifying radio "between toothpaste and hair tonic" would be in the nation's ultimate interest.

PRESIDENT ROOSEVELT'S address proclaiming an unlimited national emergency was heard by 65,650,000 people in the United States alone, according to a research firm engaged to check the audience by CBS. Washington papers: Put that in your priority pipe and smoke it!

REPAIR PARTS should certainly move up the priority scale so that receivers now in American homes can be tuned in on the news that stimulates civilian productive effort and the entertainment that keeps up morale. But we consider it shortsighted to agitate for this alone because, even with replacement parts available, some of the nation's 50,000,000-odd radios are certain to go out of service due to the difficulty and expense of repair or the fact that they are hopelessly obsolete even when restored to original operating condition. And, if you want a straight economic reason for urging that radio's priority rating be raised "whole hog," take it from us that few parts manufacturers could maintain present plants and personnel without original equipment business as a cushion.

RMA efforts to cooperate with government in connection with critical materials and still maintain enough civilian equipment production to pay the eventual defense bill continue along laudable lines. We've already told you about rules regarding aluminum and nickel, self-imposed by manufacturers. Now, we understand, their Association is facilitating swapping of dope about substitutes. Eventually, it is not beyond reason to suppose that factories may even swap actual materials, where their stocks are short on one thing and long on another. Democracy is finding the way!

MUSIC TRADE SHOW exhibit space sale to radio manufacturers and particularly those firms making record playing instruments and accessories, recorders, pickup devices and amplifiers, has upped each year and is particularly heavy for the show to be held in New York's Hotel New Yorker July 29 through Au-



gust 1. So says executive secretary W. A. Mennie of the sponsoring National Association of Music Merchants, charged with the conduct of the group's 40th Annual Convention.

SPEAKING OF MUSIC, you've probably already heard about that new automatic record-changer that mechanically flops disc over so that sides may be played in sequence and you may have picked up rumors about the device in process of design that does a similar job by holding the disc still and flopping the pickup from top to bottomside. But have you heard about the proposed one that uses two pickups in a jaw-like arm, gripping the platter more or less between two needles?

MORE MUSIC in the wind involves higher fidelity records using a special material further reducing surface noise. Understood to be lateral cut, as usual, these would cost two or three dollars, carry classical stuff exclusively at first. Probably won't be announced during the present emergency but experimental work known to be in progress for several years is apparently nearing a conclusion.

PRACTICING what we preach in this issue's front-of-book editorial emphasizing the importance of management that makes a profit during the emergency rather than mere volume, we've included several articles directed along such lines. Note particularly: "Quality Sales Take Technique," "Do You Finance Your Own Paper," "How to Make Inspection Charges Stick" and "Servicing High-Fidelity Receivers." More will follow concerning methods of increasing net in coming numbers.

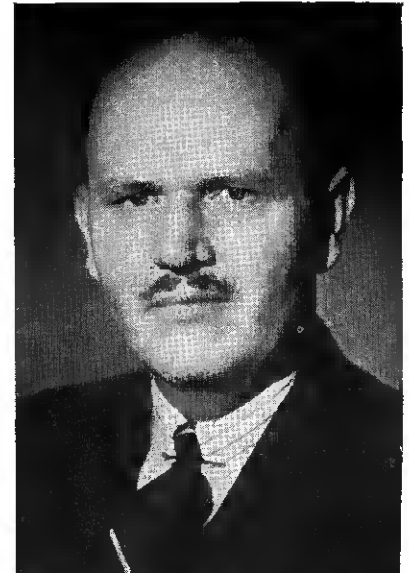

NORGE ADMAN—Charles H. MacMahon, newly appointed advertising manager of Borg-Warner's Norge Division, was formerly sales manager of the firm's Detroit Vapor Stove Division

NRPDA Meets

Set-up new district chapters and elect temporary directors

CHICAGO—At its annual business meeting, during RMA Chicago convention, the NRPDA voted that a new set-up was advisable and that the Association should be reorganized in such manner that it function primarily through district chapters and that the responsibility should be upon the shoulders of a director elected by member jobbers in that district.

In line with this motion the following temporary regional directors were elected: Washington-Oregon territory, R. Bargelt; California, Emmett N. Hughes; Florida, H. M. Carpenter; No. Car., Va., & Wash., D. C., Leslie C. Rucker; Wyoming-Utah, Chas. A. Houge; Oklahoma, Arkansas, & Louisiana, Wm. A. Shuler; Georgia, S. Car. & Tenn., J. C. Jordan; E. Penn. & Maryland, Geo. D. Barbey; New York City, Ben Miller; Cleveland & Pittsburgh, Emmett Tydings; Illinois, Ralph E. Walker; St. Louis & Kansas City, Robert M. Smith; Tennessee & Alabama, Eben E. Nelson; Missouri, Michael Ebinger; Kentucky, Jesse Tillett; New York State (Buffalo, Erie) Arthur C. Stallman; Wisconsin, S. M. Brown; Minn., No. & So. Dak. Wis. & No. Iowa, David S. Goode; Michigan, George Wedemeyer; New Jersey, Aaron Lippman; and Texas, Elliott Wilkinson. Directors at large: John Stern of Philadelphia and Wm. Shoning, Chicago.

These directors unanimously elected George D. Barbey of Reading, Pa., temporary president and Arthur Moss, executive secretary, who was also asked to continue in office on a temporary basis, which he agreed to do.

On the Newsfront

Music Trade Convention

Thirty-two radio concerns reserve space

NEW YORK—Each year, more and more radio manufacturers are reserving space at the annual Convention and Music Trade Show. (To be held this year at the Hotel New Yorker, New York City July 29-Aug. 1).

To-date, approximately 160 companies in the music field are signed up to show their products at this show. Included in this total are the following 32 well known radio receiver and record manufacturers and concerns producing accessories for the radio field:

Amperite	Magnavox
Ansley	Muscraft
A. Bitter Const.	
Boetsch Bros.	Peerless Album
Brunswick	Philco
	Pilot
	Presto
Capehart	Recordaid
Columbia Rec.	RCA Mfg.
Duotone	
Decca	Schloss Bros.
Emerson	H. Royer Smith
	Stromberg-Carlson
Espey	
Farnsworth	Tunnis Bros.
Favorite.	
Freed	United Pressed Prod.
Fibra Devel.	
Galvin	Waters Conley
General Electric	Widder Bros.

U. S. Radio Exports

So. America, Uncle Sam's biggest customer

WASHINGTON—Radio equipment exported by American manufacturers for month of March came to \$2,452,281, according to advance reports issued by Bureau of Foreign and Domestic Commerce. Of this amount there was over one million dollars worth of radio receivers comprising some 77,499 sets.

Reported that largest purchaser was Chile with 8840 sets worth \$183,798. The Union of South Africa was second with 31,880 sets, worth \$178,464. Mexico right behind, followed by Cuba and the Netherlands Indies.

FCC Extends Time

WASHINGTON—In order that the networks and stations concerned with the FCC's May 2nd. ruling on "Chain Broadcasting" shall have ample time for adjusting themselves to new requirements, the Commission on June 23rd, amended the last paragraph of its ruling, whereby the effective date of com-

pliance may be extended from time to time to permit the orderly disposition of properties.

RMA Elects Officers

Knowlson again president. Four more firms admitted to membership

CHICAGO—J. S. Knowlson has been reelected president of the Radio Manufacturers Association, will pilot this group through the 1941-1942 season.

Vice-presidents reelected include Paul V. Galvin, Roy Burlew and H. E. Osmun, with James P. Quam joining their ranks for his first term.

Treasurer of the RMA is again Leslie F. Muter with Bond Geddes continuing as executive vice-president and John W. Van Allen as general counsel.

Newly elected directors include R. C. Cosgrove, E. F. McDonald, Jr. and James P. Quam.

Firms just admitted to membership include Air King Products of Brooklyn, General Magnetic of Detroit, Majestic Radio & Television of Chicago, Oxford Tartak of Chicago, and Zenith Radio of Chicago.

Refrigerator Price Ceiling?

WASHINGTON — Leon Henderson, "head man" in the Office of Price Administration and Civilian Supply, on June 23 wrote 16 household refrigerator manufacturers said to be responsible for 97 per cent of this industry's output, requesting that no additional price advances be made without prior discussion with OPACS.



"MAC" MOVES EAST—Fada Radio & Electric's president J. M. Marks (left) has just appointed McMurdo Silver (right) vice-president in charge of a newly created Special Equipment Division which will concentrate on the design and production of receivers, transmitters and similar electronic devices for commercial clients and the national defense program

Reps Elect New Officers

NEW YORK—At its 6th annual convention, held in connection with recent Radio Parts Industry Show, at Chicago, "The Representatives" elected the following officers for the ensuing year: Sam MacDonald, reelected president; David Sonkin, reelected secretary-treasurer; and Irvin I. Aaron, vice president. Board of Governors: Dan Brittan, Perry Saftler, J. P. Kay, H. W. Burwell and W. E. McFadden. Ben Joseph, reelected director of publicity.

The following five new chapters were installed: Missouri Valley, Wolverine, Buck Eye, New York and Philadelphia.

Applications for membership were accepted from Arthur E. Cerf, New York, Walter J. Bauman and C. R. Bluzat of Chicago, Fred J. Stevens, Detroit and Mose Branum of Texas.



HELPED SELL SYLVANIA—Helping Hygrade-Sylvania's Henry Johnson (left) promote goodwill for the line during Servicemen's Day at the recent Parts Show were (left to right) W. C. Braun Company salesmen L. L. Lynn, R. L. Squires, J. C. Cemje, W. C. Grady and W. T. Moran

ELECTRONIC VIBRATORS

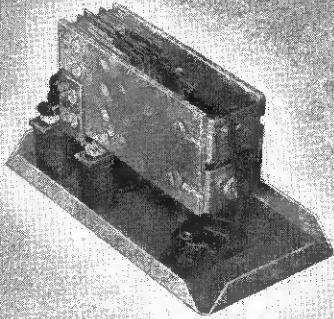

... The Industry's Standard for Mobile Amplifiers!

THE selection of *Electronic Vibrators* by the following major manufacturers of public address systems . . . over 95% of the industry . . . is sincere tribute to the high efficiency and unequalled dependability which *Electronic* builds into its product:

- Barr Manufacturing Company
- Erwood Sound Equipment Company
- The Hallicrafters
- Knight
- Montgomery-Ward
- Rauland Corporation
- Sears-Roebuck
- Transformer Corporation of America
- Webster-Rauland Corporation
- And many others

Illustrated (at top) is the Type 490 Heavy-Duty Vibrator with which most amplifying systems are equipped. It is self-contained, precision-built for long, trouble-free operation . . . with accurate 60-cycle adjustment and easy "plug-in" servicing.

In addition to being the overwhelming *first choice* for commercial applications, *Electronic Vibrators* are widely used by the American Defense Forces . . . fully meeting the rigid tests and specifications of the U. S. Army, Navy and Coast Guard.

To assure maximum customer satisfaction, and save yourself time, trouble and money, insist on *Electronic Vibrators* in the amplifying equipment you sell!

ELECTRONIC LABORATORIES

INC.

INDIANAPOLIS, INDIANA

New Admiral Sets Shown

Distributors see Continental's latest models, applaud low priced automatic players, combo with built-in albums, FM job

CHICAGO—"Admiral" radio and phonograph distributors from the middle west, southwest and west coast, gathered at the Hotel Knickerbocker here June 23, applauded introduction by vice president J. Harry Clippinger of fifteen table model radios, two consoles, three record players and seven radio-phonograph combinations. Particularly interesting to the 100 or more assembled was an extremely low-priced new automatic record player designed for direct attachment to radios, complete new electric phonographs, a console combination with built-in record albums and "hideaway" radio as well as "slideaway" changer and Clippinger's announcement that one topflight console would include FM under \$100.

President Ross D. Siragusa, speaking at the meeting, pledged his company would do everything possible to produce as many sets as distributors needed, said the company's January introduction of initial 1941-1942 models gave it "the jump" on competition because materials were necessarily ordered several months early, informed distributors that supply of the line's highest quality models would nevertheless be most liberal in order to use available parts to best possible profit advantage for the factory, distributors and dealers alike.

Shown by Continental's advertising manager Walter Aeverman were new display and promotion pieces. Aeverman also outlined extensive consumer advertising plans for the present season.

On June 26 Continental duplicated the meeting at New York's swank Essex House, over 75 eastern distributors and their salesmen attending. Ross Siragusa unveiled models, described promotion and

advertising plans, following introduction by Dale Radio's Maurice Despres, who later staged a party for distributors at the famed "Diamond Horseshoe."

RCA Meeting

Show radio opportunities for new electronic arts

CHICAGO—A glimpse into the future of the electronic arts, together with a realistic view of a steadily expanding business in fields other than radio, were unfolded, during convention week, before more than 200 RCA Tube and Equipment Distributors from all parts of the country.

The "Electronics on Parade" feature, as it was named, presented to the distributor guests the RCA Electron Microscope, the latest types of television equipment, and other modern advancements of the RCA Research Laboratories. Announcement of the addition of a line of RCA sound equipment for the service field was made at the same time.

A delegation of RCA executives from Camden, including Robert Shannon, Executive Vice-President, were on hand to meet with the wholesalers.

Bruno and RCA Victor

Fete Dealers

NEW YORK—Some 6,000 metropolitan area record dealers and their friends were guests of Bruno-New York, Inc., Metropolitan RCA Victor distributor, and the RCA Manufacturing Company at Monte Proser's mammoth new Dance Carnival in Madison Square Garden on Monday and Tuesday evenings, June 9 and 10.

Marty Joins Shure

CHICAGO—Joe Marty, former secretary of the Radio Servicemen of America has joined Shure Brothers, of this city.



GIBSON MEETING—F. E. Basler, g.s.m. of Gibson Electric Refrigerator Corp., outlining features on his company's "Freez'r Shelf" line to group of retail salesmen brought to factory by distributor, Moon Bros. of Detroit

ATLANTIC CITY CONVENTION



ON THE PLATFORM—Philco's sales manager, *Thomas Kennally* outlines, to large jobber gathering, new advancements of 1942 radio line



MGR. COMPACT SALES — *Larry Hardy* unfolds features of Philco's latest portables and table models

Emerson Announces New Penn. Jobber

NEW YORK—Emerson Radio and Phonograph Corp. announces the formation of Emerson Radio of Pennsylvania, Inc., with headquarters at 2116-Arch Street, Philadelphia. Will serve eastern Pennsylvania, southern New Jersey and the state of Delaware.

The company's operations will be in charge of A. Irving Witz, its president, who is well known throughout the industry.

Opens Export Office

NEW YORK—Amplifier Co. of America, this city, announces the opening of its export office at 36 Pearl St., under the direction of R. V. Collins. J. J. Sloane, former export manager, will now handle all government defense contracts.

Eckstein Buys L'Tatro

Developing new type farm radio for introduction in Fall

LE ROY, MINN.—From E. A. Eckstein, chief engineer and general manager of the newly formed Eckstein Radio & Television Company, comes word that this firm has purchased the complete business and stock of the L'Tatro Manufacturing Company of Decorah, Iowa.

Factory and offices of the Iowa firm long famous for its original work in connection with 32-volt sets and pioneering in the 6-volt d.c. receiver field move to LeRoy, where Eckstein is at present completing design of a high-

quality battery model said to have outstanding performance features and scheduled for release in the Fall.

Newspaper Hearing Postponed

WASHINGTON—The Federal Communications Commission has postponed its hearing (originally scheduled to begin June 25) in connection with Order 79, to determine what policy or rules if any should be promulgated concerning newspaper operation of high frequency FM broadcast stations and future applications for standard broadcast stations by newspapers.

New hearing date is July 23.

Things to Take Along to Make a Good Connection

Good radio service usually requires more than tube replacement, which any clerk might handle. As a professional serviceman—you can easily find the other troubles that interfere with good reception. A new antenna, a power line filter, hook-up wire, or one of the many other radio wire accessories may restore that "brand new" set condition. Take them along—give satisfaction to your customer—get the real profits your knowledge of this business deserves.

You'll find these fast selling items and many more in the Belden radio wiring line. Make a good connection—buy Belden from your jobber.

Belden Manufacturing Company
4697 W. Van Buren St., Chicago III.

Belden Wire
FOR GOOD CONNECTIONS

- All Wave Antenna Systems
- Terminals
- Extension Cord
- Replacement Cords
- Indoor Aerial Wire
- Ground Clamps
- Lightning Arresters
- Power Line Filters
- Hook-Up Wire

Defense and Radio Sales Problems

Zenith's J. J. Nance declares emphasis must be placed on management

NEW YORK—The radio and appliance industry made a material contribution toward a working-out of the new sales problems which confront business as a result of the defense program, recently, when J. J. Nance, vice-president and director of sales of Zenith Radio Corporation, addressed a group of more than 1000 sales executives attending the 6th Annual Convention of the National Federation of Sales Executives, held in Cincinnati, Ohio.

Nance, who is recognized as one of the outstanding merchandising authorities in the radio field, spoke on the topic of "Selling in a Seller's Market."

Pointing out that the defense program had presented sales executives with the most complex problem they have ever faced, Nance declared that the problems of sales management have shifted from an emphasis on sales to an emphasis on management.

"A sales executive's No. 1 job at the moment," Nance said, "is the proper distribution of merchandise to customers. With consumer demand continuing to increase and production being limited more and more by priorities, a carefully planned system of allocations has be-

come a necessity, and we must now concentrate on selective distribution and on fortifying dealer loyalty."

"But nevertheless," he added, "we must also look to the future. We must prepare ourselves now for a supreme selling effort when conditions return to normal."

Zenith Shows 1942 Models

CHICAGO—J. J. Nance, newly appointed vice president and director of sales of Zenith Radio Corp., reports a two day business conference of its wholesale distributing organization was held June 26-27, at the Drake Hotel, Chicago, to discuss mutual problems brought about by the national defense program and the present state of emergency. At the same time the jobbers previewed eighteen 1942 Zenith models, largely composed of the higher-priced consoles, combinations and FM sets.

Despite the present "seller's market," Nance, in his address, pointed out that dealers would be given more aggressive help than ever before and there would be no letup in its sales promotional and advertising program.

Acme Appoints Boston Rep.

BROOKLYN—I. Schub, president of the Acme Battery Corp., of Brooklyn, N. Y., announces the appointment of Max Alberts, 66 Glen St., Boston, Mass., as its Hub city representative.

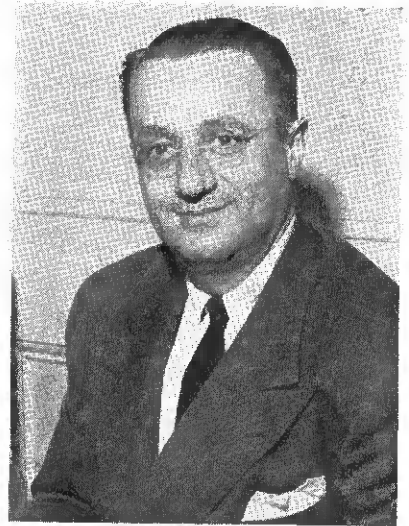

NEW FARNSWORTH DISTRIBUTOR—Max E. Hegleman, eastern New York "oldtimer" in the business 20 years and with a wide following of dealers in that area, has formed a firm named "Your Friendly Distributor" at Albany, will handle Farnsworth products from offices and showrooms at 12 Sheridan Avenue

Broadcast Industry Sets New High

WASHINGTON—The broadcast business in the United States reached a new high of \$154,823,787 last year, which was an increase of \$24,855,761, or 19 per cent, over the figures for 1939, according to annual financial data today released by the Federal Communications Commission. This amount was for sale of time only, as reported by three major networks, five regional networks, and 765 stations.

In consequence, the broadcast service income (operating profit) of the entire industry increased in 1940 by more than \$9,000,000 over 1939, or about 39 per cent.

Franklin Electric Receives Admiral Distributorship

CHICAGO — Continental Radio and Television Corp., of this city, reports the appointment of Franklin Electric Company, 117 North Seventh St., Philadelphia as its Quaker city distributor of Admiral receivers. Franklin Electric has been a dominant factor in the jobbing market in this city for many years. In conjunction with the appointment, a presentation of the complete Admiral line was held for their dealers at the Hotel Warwick.

Ansley Moves

NEW YORK—Factory, offices and showroom of Ansley Radio Corp. are now located at 21-10 49th Ave., Long Island City, N. Y. New quarters to provide greatly increased space for all departments,

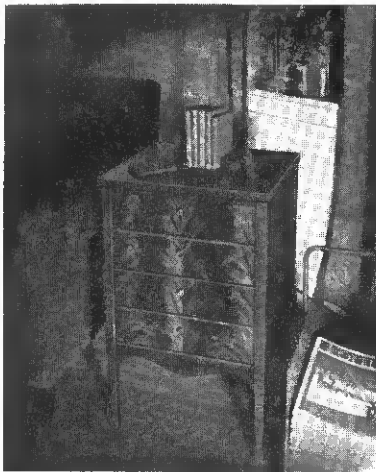

The Oxford by Ansley \$129.50 AC
Oxford Twin Record Cabinet \$34.50
(Prices slightly higher west of Rockies)

Consoles, chairside models, matching record cabinets, table models, portables, combinations and phonographs, period and modern designs, in Walnut, Mahogany and Maple with 13 distinctive finishes, automatic and non-automatic for AC or AC-DC operation. Priced from \$69.50 to \$525.

Frequency Modulation optional with all consoles

ANSLEY RADIO CORPORATION

21-10 49th Avenue

LONG ISLAND CITY, NEW YORK

ANSLEY DYNAPHONE
Reg. U.S. Pat. Off.
"Superb Tone from Records and Radio"

The **TRADE MARK** that means
PROFIT for you—SATISFACTION
for your customers

This season STOCK ANSLEY

GREATER VARIETY

**NO SEASONAL
OBSOLESCENCE**

PROTECTED FRANCHISE

CUSTOMER SATISFACTION

Visit the **ANSLEY EXHIBIT** at the
TRADE SHOW, Rooms 817 and
826 Hotel New Yorker, July 29-
30-31 and August 1, 1941.

Freed To Form New Sales Policy

NEW YORK—Word comes from the Freed Radio Corp. that Arthur Freed, vice president, will make known shortly a new sales policy that has been formulated to make the Freed-Eisemann line of radios an important national factor in the music and radio trades.

The keystone of the sales plan is a restricted franchise, based upon what each market may be expected to produce in sales and made available to the limited number of dealers who can logically sell a quality FM line, supported by national, cooperative newspaper and point-of-sale advertising.

Details of the new program are being completed and will be announced to the trade within the next few weeks.

New Instruction Manual

NEW YORK—Radiolab Publishing Company, Brooklyn, N. Y., announces publication of a 78-page book by Sol. D. Prensky entitled "Radio Laboratory Job Sheet Manual." Features "Learn by Doing" technique with instructions adopted to school laboratory work. Covers the experimental work for a one year's basic radio course. Starts with electrical connections and works up to a 6-tube superheterodyne receiver.

G-E Launches Tube Trade-Ins

BRIDGEPORT—General Electric is currently encouraging the trade to swap old tubes of any brand for premium certificates issued by its distributors when a comparable number of new GE types are purchased, offers to redeem such paper with test equipment and other merchandise at present being catalogued between 50 and several thousand "certificate units."

Object of the plan, according to manager of tube and special receiver sales Howard Bennett, is to aid the firm's tube distributors unearth new accounts. Most of the plan's cost, he advises, is born by headquarters.

Johnson Upped By G-E

NEW YORK—Appointment of Howard E. Johnson as operating manager of the metropolitan distributing branch of the General Electric Company here, handling radio, appliance, heating and air conditioning lines, has been announced by Earle Poorman, manager. Johnson succeeds P. L. Griffin, who has left the company to accept a position in Chicago.

G-E Portable Promotion

NEW YORK—General Electric's new line of portable radios, featuring the self-charging storage battery radio, is be-

ing introduced to more than 10,000 dealers from coast to coast in a series of meetings sponsored by G-E's Retail Development League.

DuMont Opens New Offices

NEW YORK—New sales offices have just been opened here in suite 1714 at 515 Madison Avenue by Allen B. DuMont Laboratories of Passaic. Occupied by Mark B. Lajoie, Dave Gross and Jim Blackburn, these new quarters will have facilities permitting demonstration of television to both the trade and the public. DuMont's television studios and station W2XWV occupy the entire 42nd floor of this same building.

PRSA Meeting

PHILADELPHIA—The Philadelphia Radio Servicemen's Assn. recently held a special meeting at its quarters in the Architect's Building, this city, to discuss the problems of servicing battery portables and the probable battery design changes in the new 1942 lines.

ASM For Ken-Rad

OWENSBORO—Russell W. Metzner, Sales Manager of the Ken-Rad Tube & Lamp Corporation, Owensboro, Kentucky, announces the appointment of Leslie E. Septer as assistant sales manager in charge of renewal tube sales.

See the More Positive Action of TURNER Push-Pull VIBRATORS



With "Strobotac"—the stroboscopic light, the human eye can see the fastest action as tho in a slow-moving picture. It clearly lets you see the action of a Turner vibrator in contrast with an ordinary vibrator.

1 Push-Pull in contrast with an ordinary vibrator.

Diagram 1 shows the action of an ordinary vibrator, as seen in front of the Strobotac. Note the shorter swing of the reed—the unbalanced pressure of contact points.

2 Diagram 2 shows Push-Pull action in front of the Strobotac. Actually lets you SEE the wider, perfectly balanced swing of the reed, resulting in increased contact pressure and decreased contact resistance.

Compare the wider swing of the reed, the emphasized wiping action of the contact points, and the steady, chatter-free operation. No wonder Turner Push-Pull Vibrators offer longer, trouble-free life. Jobbers, dealers and service men who saw this demonstration at the Radio Parts Show are ordering by the score! You, too, can cash in by finding out about Turner Push-Pull Vibrators NOW!

FREE—16 page manual for Radio Service Engineers, giving a wealth of technical information and explanation of Turner Push-Pull Vibrators. Send for yours TODAY!

New TURNER CARDIOID Mike Licks FEEDBACK



2-Element Generator for True Cardioid Characteristics

Extremely Sensitive to Sounds in Front—DEAD at rear.

Turner Cardioid Model 101

Outperforms Many Mikes Costing Twice the Price!

Deal a death-blow to feedback with the new Turner Cardioid! It's the answer to the sound man's problems. Offers the best features of both the velocity and dynamic, in the most efficient microphone yet produced by modern precision engineering. Where the going is tough, and acoustic conditions practically impossible, a Turner Cardioid will do the job!

101A—Standard Model, all impedances, List... \$55.00
101B—De Luxe Model, same as 101A, except has 3-position switch. List... \$65.00
101-C—Broadcast Model, same as De Luxe, with range extended to 10,000 cycles. List... \$70.00

WRITE NOW FOR COMPLETE DETAILS



**TIME TO TURN TO
TURNER MICROPHONES
99
TURNER VIBRATORS
22
TURNER**

The TURNER Company • • • 915 17th St. NE., Cedar Rapids, Iowa

Crosley Sales Conference

Officials report increased lines for '42. Facilities provide for both domestic and Government needs

CINCINNATI—In spite of the fact that a sizable part of Crosley's facilities are now devoted to production for national defense, vice president and general manager R. C. Cosgrove, and general sales manager Robert I. Petrie, at concern's annual sales conference of zone and district managers, emphasized the fact that there would be an increase in production and distribution in Crosley's 1942 radios, refrigerators and other major appliances.

Both officials pointed out that the company is fortunate, that it has available ample manufacturing space to provide fully for both domestic and government needs.

In presenting the new radio line, J. H. Rasmussen, manager of radio division, pointed out that quality has been the first consideration this year in every model, and that prices, while competitive, have been subordinated to quality angle. L. Martin Krautter, manager of advertising and sales promotion, outlined his plans for new models. J. F. Crossin, manager of refrigeration division, addressed the gathering on this department's new program.

Nash-Kelvinator Ups Pierce

DETROIT—George W. Mason, president, Nash-Kelvinator Corp., announces that Frank R. Pierce, formerly general sales manager of the Kelvinator Division, has been elected to fill the newly created post of vice-president in charge of sales.

Pierce will direct the sales and advertising activities of both the Kelvinator and the Nash Motors Divisions.

Charles T. Lawson, who has been sales manager of Household Appliances, will succeed Pierce. E. Ray Legg, former Western sales manager succeeds Lawson as s.m. of Household Appliances and Don Rulo takes Legg's place as Western sales manager.

Weston Appoints

Western Rep.

NEW YORK—Weston Electrical Instrument Corp. of this city, just announced the appointment of Edward S. Sievers as its representative with headquarters at 417 S. Hill St., Los Angeles, Calif. John D. Farneman will be associated with Sievers in this territory.

Casagrande Joins Majestic

CHICAGO—John G. Casagrande, former district sales manager for Zenith Radio Corp., has just been named assistant to E. A. Tracey, chairman of the board and general manager of Majestic Radio and Television Corp. Casa-

grande will assist Tracey in formulating Majestic's new sales policies and appointing distributors throughout the country.

Sylvania News for Trainees

NEW YORK—The editors of Sylvania News, house organ of Hygrade Sylvania Corp., have arranged to send the publication regularly to the respective army post addresses of its readers who have answered the call to the colors. At the same time, correspondence relating to radio is solicited and trainees are invited to write of their personal Army experiences.

Paul Zimmerman

Heads Airtemp Sales

DETROIT—Paul B. Zimmerman, formerly vice president and treasurer of Grace and Bement, Inc., local advertising agency, has just accepted the appointment of vice president and general sales manager of the Airtemp Division of the Chrysler Corp. Previously held vice-presidency in charge of sales and assistant to the president of the Norge division of Borg Warner Corp.

Zimmerman will have charge of Airtemp's entire sales organization, advertising and merchandising activities.

Brunswick Expands

NEW YORK—Herbert L. Weisburgh, sales director of Brunswick Radio and Television Division, announces the opening of the company's new and enlarged offices at 244 Madison Avenue, New York City.

These new facilities will include a permanent studio display of Brunswick models.

Distribution News

ADMIRAL—Continental Radio and Television Corp. announces the appointment of the following three new distributors for Admiral radio receivers: *Kaemper-Barrett, Inc.*, 246 So. Van Ness Ave., San Francisco, Cal., *Modern Appliance & Supply Co. Inc.*, 4300 Washington St., New Orleans, La., and *Radio Distributing Co.*, 235 Market Ave., S.W. Grand Rapids, Michigan.

CROSLEY—Announces that *Huey & Philip Hardware Co.*, 1900 Griffin Street, Dallas, Texas has just been granted a franchise to handle the Crosley line of appliances in the Dallas area.

COLUMBIA—Paul Southard, sales manager of Columbia Recording Corp., announces the appointment of *Bennett Radio Co. Inc.*, 211 North Fourth St., Columbus, Ohio, as its distributor of discs in Columbus territory.



FOR G-E DEALERS—Harry Deines, General Electric's advertising manager, presents new snappy "small set" merchandiser. Theme of message is cleverly outlined in top poster

Dealer Helps

SOUND EQUIPMENT CATALOG

—*Emco Radio Products, Inc.*, 78 Reade St., New York City introduces a 7-page catalog illustrating its sound equipment merchandise for modern sound installations.

FM-AM AMPLIFIER MANUAL

Thirty-two-page booklet describing and illustrating new and interesting circuits. Measures 8½x11 inches and costs 20c. Write to *Amplifier Co. of America*, 17-29 West 20 St., New York City.

ANTENNA MANUAL

—1941 edition edited by Arthur H. Lynch, Managing Director W2USA, is published by *Pre-max Products, Div. Chisholm-Ryder Co. Inc.*, Niagara Falls, N. Y. In this issue are featured rotary beams, vertical radiators, FM antennas, vertical beams, extended double zepp, commercial and police antennas. 32 pages. Price 25c.

KIT DISPLAY

—*Hygrade Sylvania Corp.*, 500 Fifth Ave., New York City offers to the jobbers a counter display card for its panel lamp kit. The kit contains 60 lamps with 5 different types. The counter card slips over the open kit and attracts attention with bold type.

FM BOOKLET

—"The ABC of FM" published by *Freed Radio Corp.*, 39 West 19 St., New York City has 15 questions and answers on frequency modulation written in a small 8-page booklet. Such questions as "What is FM? What does FM accomplish?," etc., are fully answered.

DISC DISPLAY

—The wire rack disc display of the *National Recording Supply Co.*, Hollywood, Calif., shows two price groups in different sizes with ample storage space in back for extra stock. A string of 5 multi-colored discs strung at the top adds to its attractiveness.

TUBE DISPLAY FOLDER—"Ken-Rad On Parade" is the title of a pamphlet illustrating display material available to the dealer. Keyed with the national defense program, animated cartoons and tubes appear in military settings. Write to *Ken-Rad Tube & Lamp Corp.*, Owensboro, Kentucky.

COMPLETE LINE CATALOG—A new 20-page catalog, known as No. 11, has just been released by *Howard B. Jones*, 2300 Wabansia Ave., Chicago, Ill., illustrating and describing its complete line of multi-contact plugs and sockets and terminals. Copy will be sent free upon request.

FLOOR DISPLAY—Latest attractive room setting display designed to present the new 1942 radio models of the *Philco Radio Corp.* The background of the display creates a home atmosphere and thus shows the purchaser how the models will appear in the home.

TRANSMITTING TUBES—*RCA's* finest and most complete engineering and amateur guidebook on its transmitting tubes, comprising 72 pages covering 69 types, five transmitter layouts and 150 circuits, is just off the presses. Obtainable for 25 cents from the company's Tube and Equipment distributors or from the *RCA Commercial Engineering Section*, Harrison, N. J., if remittance is inclosed.

GENERAL AIDS—Catalog 142 by the *General Cement Mfg. Co.* of 919 Taylor Ave., Rockford, Ill., contains complete data concerning the company's line, including new products such as service cement in improved bottles, hammer finish kits, cabinet repair kits, phono stylus setscrews, a new knob-puller.

CONDENSER CATALOG—and literature entitled "Defense And You" just

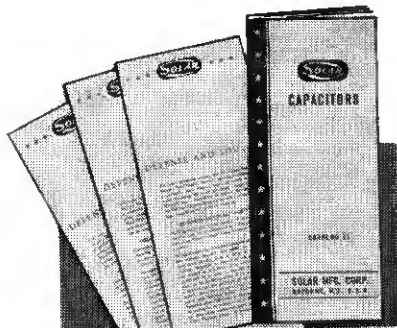

released by *Solar Mfg. Corp.* Catalog contains 36 pages with illustrations and specifications. Free.

SOUND POSTER—*Atlas Sound* of 1447-51 39th St., Brooklyn, N. Y., has a new 17 by 14 inch poster printed in flashy yellow and black for merchandisers of microphones, loudspeakers, amplifiers and complete systems to put

in their windows. Pictures show 22 unique applications. Free on request.

1942 DISPLAYS—*Crosley Corp.* announces three new dealer displays for its new 1942 radio line. All are exemplified visually under the theme of "The Rainbow of Sound." The de luxe display embraces 2 consoles and 8 table models. So arranged that each side unit can also be used as a single background display. Included in the new group is the life-size "Rainbow Girl" display in eight colors.

33-PAGE ANALYSIS—On new FCC rules in radio broadcasting and what these new rules mean, just issued by *Columbia Broadcasting System*. For copy write to Columbia, 485 Madison Ave., New York City.

COUNTER DISPLAY—*Recoton* offers a "Connie Boswell" color display centered with her picture and endorsement of *Recoton* "Phoneedles." Also a "silent salesman" poster of Jimmy Dorsey and his orchestra recommending its needles.

CONVERTERS ET. AL.—A bulletin numbered 13-25 by *Janette*, gives complete data concerning this firm's line of rotary converters, dynamotors. Address, 556-558 West Monroe Street, Chicago.



IT'S SPILL-PROOF!

The New Rechargeable

Willard Radio Battery

● Here is a revolutionary new product developed by Willard engineers. Its exclusive construction keeps the electrolyte from spilling, even if tilted or operated upside down. Its transparent plastic container is unusually strong. Has an automatic ball-type Charge Indicator built right into the case, always visible. Constant voltage guarantees good reception, fine tone quality. Ease of recharging means real economy.

WILLARD STORAGE BATTERY COMPANY • Cleveland • Los Angeles • Dallas • Toronto

SEE IT IN THE NEW G-E SELF-CHARGING PORTABLE RADIO
Operates on its WILLARD Storage Battery or on A. C.—automatically self-charges while operating on A. C.—supplies both "A" and "B" power, no dry batteries needed.

BENCHES

before and after

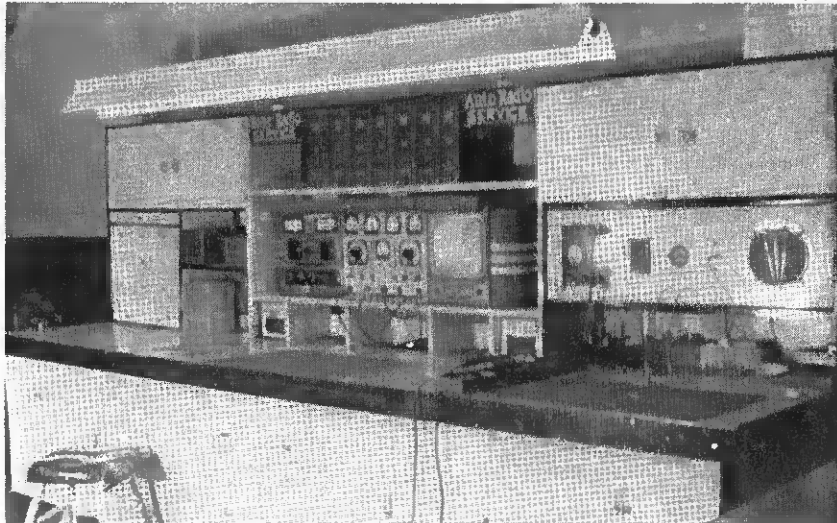
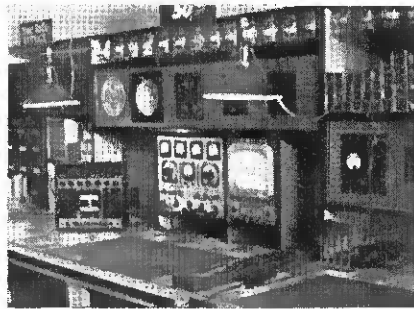

Acme Radio Shop, Jackson, Mich.

Charleston Electric Co., Charleston, Mo.

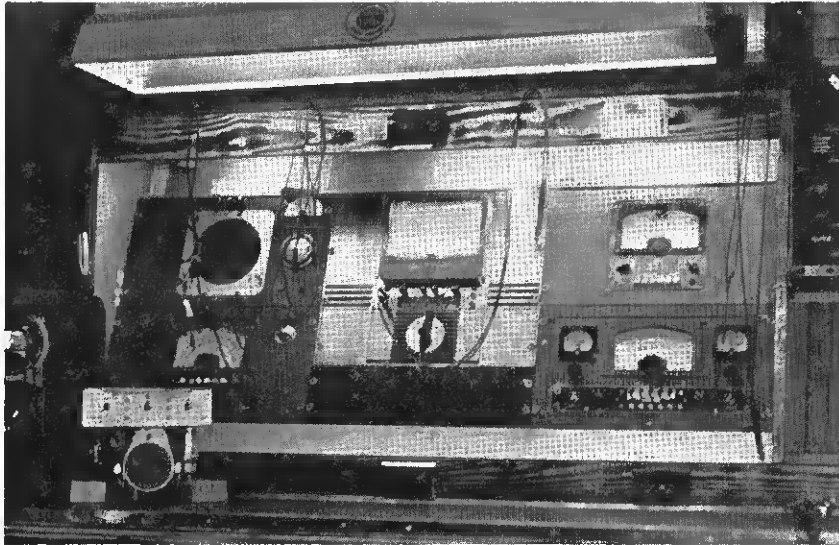

NO LEG SHOW—By dressing up bare bench legs and space with white cabinet doors and duplicating method on test panel for spare parts and tubes, D. E. Clemons made an attractive, cool looking bench at Acme Radio Shop, Jackson, Mich. (Top photos)

CENTRALIZED SERVICE—Metal panels and new equipment replaced plywood test board with scattered instruments for Charles Goodin and Norman Harper of Charleston Electric Co., Charleston, Mo. They report close grouping of testers has speeded up service. (Bottom photos)



New

Philco FM-AM Receiver

To permit using all the tubes in the receiver for reception of both amplitude modulated stations and frequency modulated signals the circuit shown in the large diagram is employed in Philco models 42-355 and 42-390.

Pushbutton bandswitching allows tuning of the standard broadcast band, the 9 to 15 megacycle band and the FM band from 42 to 50 megacycles. Five additional pushbuttons may be set up for stations on the broadcast band but these are not shown in the diagram since they follow conventional practice.

For standard broadcast and short wave tuning two sections of a four gang condenser cover the frequency ranges. These sections and their coils are disconnected when the FM button is depressed and the two remaining sections, each composed of three plates, are connected to tune the oscillator and mixer stages. At the same time the pushbutton connects an FM loop aerial into the circuit in place of the standard loop.

Output of the XXL mixer is permeability tuned to 455 kilocycles in the primary winding of the three coil first i-f transformer. Two secondary windings will be found in this transformer. The lower winding in the diagram is tuned to 455 kc by the upper trimmer while the lower trimmer is shorted out by the band switch. This lower trimmer connects in the circuit when FM signals are received and then tunes the upper secondary winding of the transformer to 4.3 megacycles, the i-f for FM reception. The FM pushbutton also shorts out the 455 kc winding and permits tuning of the primary to 4.3 mc by the trimmer in the primary circuit.

The second i-f transformer also contains three windings. Two of these, the primary and the upper secondary coil in the diagram, are tuned to 4.3 mc by their associated trimmers. The lower secondary winding is tuned to 455 kc for the standard bands and no switching is involved in this transformer.

The third i-f transformer contains a total of six windings, two for AM reception and four for FM signals. The upper primary winding is tuned to 4.3 mc and feeds the two upper secondary windings connected to the diode plates of the XXFM balanced detector tube. The lowest secondary winding of this transformer is also tuned to this frequency and is also em-

Circuits for 1942

played in the discriminator action on FM signals.

The lower primary winding of this transformer is tuned to 455 kc and feeds the adjacent secondary winding for AM operation. The avc voltage developed in this second detector circuit is fed through two separate avc filters to the XXL mixer and 7V7 first i-f stage while receiving AM signals. The avc voltage is removed from the mixer stage on FM reception and the grid return of this stage is then grounded.

Audio output of the XXFM balanced detector is fed to a bass compensated volume control circuit that includes a one megohm variable control for the attenuation of low audio frequencies and then to the triode portion of the XXFM tube. The plate circuit of this stage contains the usual treble control for attenuation of the higher a-f frequencies.

The output of the first audio stage feeds the grid of the upper 41 tube in the diagram. It will be noticed that the screen grid of this tube is not bypassed directly to ground or cathode but instead is connected to a 3900 ohm resistor that acts as a load for the screen of the tube. Audio voltage is developed across this resistor and coupled to the grid of the other 41 tube by the .01 mfd condenser and is sufficiently out of phase with the signal at the grid of the top 41 tube to allow proper push pull operation of the stage.

It might be well to note at this time that there are several points in the circuit of the receiver that are critical in regard to the location of wiring leads. For instance the leads from the third i-f transformer to the diode plates must be short and symmetrically spaced from the sub-base. If the capacity to the chassis of the topmost diode plate lead in the diagram is increased the discriminator curve will narrow while added capacity to the other diode plate lead will broaden this curve.

Distortion at low volume levels may occur if the grid lead of the XXFM tube is not dressed away from the discriminator coil wiring and secured by a lug on the chassis. The leads from the first i-f transformer to the FM pushbutton are also critical in this respect and if closely arranged to one another may cause harmonics from the oscillator to feed through the 4.3 mc i-f path and increase the avc voltage. A decrease in sensitivity at some portions of the broadcast band may then result.

Battery Set Electrifier

Battery operated receivers may be used on 50 to 60 cycle ac and dc 110 volt lines by means of the unit shown in the diagram.

A 35Z5GT rectifier tube has its filament connected in series with a 550

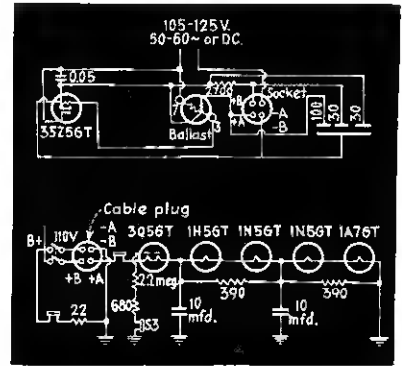

ohm section (pins 7 and 3) of the ballast tube resistor and fed from the line. Rectified voltage from the cathode of the tube is filtered by the two 30 mfd condensers and the 2700 ohm resistor to supply the B voltage for the receiver.

At the same time filament supply for the set is dropped through another section of the ballast of 2300 ohms and filtered by a 100 mfd condenser. Conducted to a socket on the chassis these leads permit insertion of the battery pack cable plug of RCA models 25BK and 25BT-3 when line operation of these sets is desired.

The bottom portion of the diagram shows the simplified diagram of the receiver filament circuit when using this model CV-42 electrifier. Although a 1.5 volt filament supply is normally used on battery operation a selector switch provided in the receiver connects the filaments in series as shown.

In certain instances hum modulation of received signals may be experienced when operating the receiver from the unit. In this case the factory advises that a 220 mmfd mica condenser may be inserted in series with

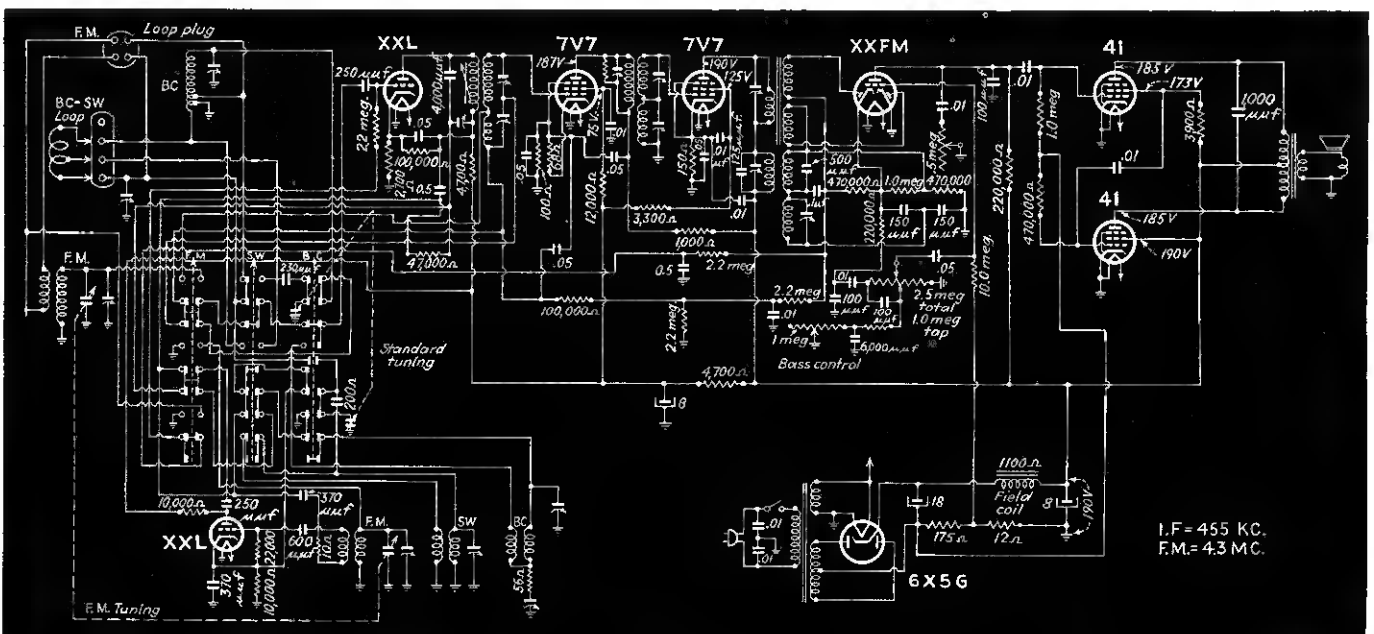

I.F. = 455 KC.
F.M. = 4.3 MC.

the antenna lead. The low end of the antenna coil may then be connected directly to the chassis and the .05 mfd condenser that formerly bypassed this point may be connected to form a series circuit from the external ground to the chassis.

4 and 6 connected to the 195 ohm section of the ballast resistor.

Another branch of the high side of the line supplies the pilot bulbs and is then conducted to the 65 ohm resistor connected to ballast pins 7 and 8. Pole

B of the switch is connected to ballast pin 8 and feeds the heaters of the rest of the tubes in the set. This pole B is also shorting the 365 ohm section of the ballast in this position.

When a locking plate on the rear

Universal Ballast

Higher voltage operation of a receiver designed for 110 volt lines may be obtained by adding or changing a ballast resistor to dissipate the additional power.

If a universal ballast resistor having several resistance sections is employed then changing from one voltage to another may be done by means of a selector switch.

The schematic diagram shows such a ballast resistor and the switch circuit for changeover from a 110 volt ac-dc line to a 220 volt ac-dc line. The switch contains three poles and is shown in the proper position for 110 volt use.

Line voltage is now applied to the push-pull parallel 25L6G tubes through the 65 ohm portion of the resistor shown. Tracing of the circuit will show that the 370 ohm portion of this resistor is shorted out by pole A of the switch while pole C shorts out pins

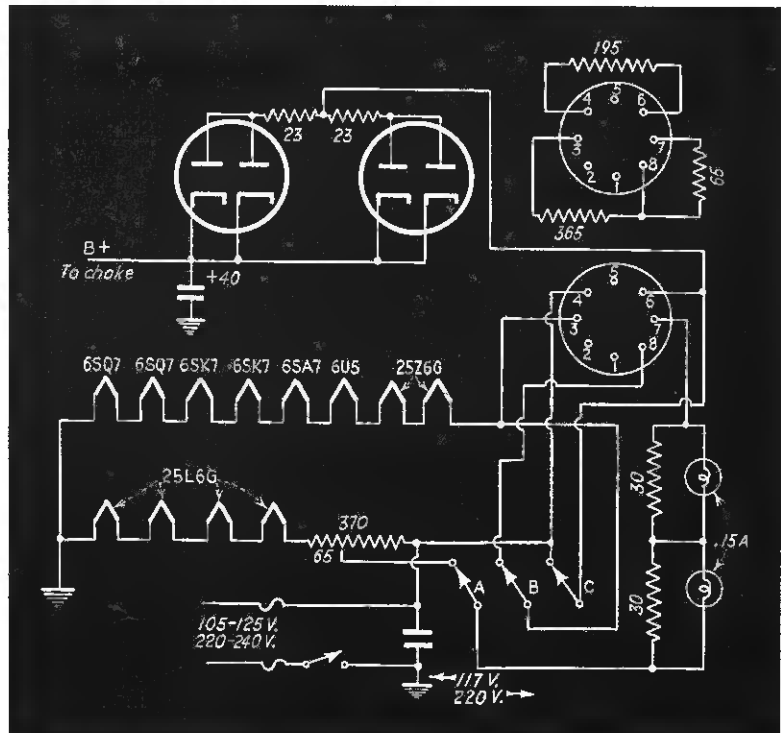

ROTARY CONVERTERS

SMALL MOTORS

DYNAMOTORS

HIGH FREQUENCY CONVERTERS

EMERGENCY POWER ANYWHERE



with **PINCOR GOLD CROWN POWER PLANTS**

These rugged, heavy duty, gasoline engine driven generators provide low cost power anywhere, any time, for electrical machinery, standby emergency services, field and construction work, portable radio equipment, charging batteries, lighting homes, boats, trailers, etc. Output up to 15 KW's A.C. or D.C. standard or special voltages; air or water cooled; gasoline, kerosene or natural gas operation. Send for new catalog and prices today.

PIONEER GEN-E-MOTOR CORP.
CHICAGO, ILLINOIS
Export Address: 25 WARREN ST., N. Y., N. Y.
Cable: SIMONICE, New York

PINCOR Products

FOR AIRCRAFT • SOUND • POWER SUPPLY USES

ERWOOD Country Club Centralized SYSTEM



Here is really something new in public address equipment. Combining automatic record changer, 9-tube radio chassis, 30-watt amplifier, and two microphone inputs in one portable unit—This model is a natural for country clubs, night clubs, and many other social gatherings where functions during the day change from one location to another. Power can be obtained from any convenient AC outlet.

Write for complete specifications.

ERWOOD SOUND EQUIPMENT CO.
221 West Erie Street Chicago, Illinois

of the Pilot 173 chassis is removed the switch may be thrown to allow operation on a 200 to 240 volt ac or dc line. The switch poles then are in a vertical position on the schematic.

Line voltage is now applied to the power tubes through the 370 ohm and the 65 ohm resistor previously mentioned and the proper voltage drop is obtained. The power line voltage is also fed to the other branch circuit, through the pilot bulbs, the 65 ohm and 365 ohm sections of the ballast and then to the rectifier and r-f tube heaters. The 195 ohm section of the ballast unit is now connected as a current limiting resistor in the plate circuit of the 25Z6G tubes that are operated in parallel.

Oscillator Biases Power Tube

In recent issues of *Radio Retailing* this department has shown the use of the dc voltage developed across the oscillator grid leak to bias the mixer stage and also as a minimum avc bias voltage but these examples are not the only ways that this voltage may be put to work.

The circuit shows another application of the developed voltage, this time to bias the audio power stage. Here the one megohm resistor feeds the dc voltage to the grid return of the 3S4 tube while r-f energy is bypassed by the .1 mfd condenser.

This method of bias is employed in the model 34 of Fada when the set is operated from batteries. The filaments are then in parallel and the 1.5 volt filament battery will not suffice for proper bias on the power tube. A resistor in the negative B line might also provide this bias voltage but then the voltage drop through the resistor would in effect be deducted from the available B voltage for the plate supply.

For ac-dc operation of this receiver the battery-electric selector switch grounds this bias line to the chassis and connects the filaments in series for operation from the 35Z5 rectifier. The 3S4 tube is then connected at the positive end of the filament line and the difference in potential between its filament and the chassis provides sufficient bias voltage.

It only remains for some enterprising genius to evolve a method to light the tube filaments and supply plate

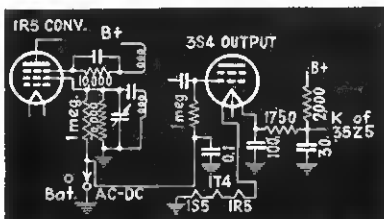

voltage from the oscillator grid leak to provide the power-less radio of tomorrow.

Circuit from England

The latest issue of the *Murphy News*, house organ of an English radio manufacturer, reveals interesting technical changes in circuits made necessary by the war situation.

The armed forces require most of the production capacity of parts manufactured and these changes are necessary for this reason rather than because of a scarcity of raw materials.

Particularly noted is a shortage of combined oscillator-mixer tubes. Two tube arrangements are now common, employing separate tubes for each function. Stocks of older types of tubes seem to be plentiful and new receivers employ these in many cases since more recently announced types are not readily available. Resistors are available but sizes are limited and series combinations are used to reach certain higher values that can not be obtained.

Savings in the use of tubular condensers are necessary and the diagram shows an original circuit and the new circuit employed to save two condens-

GET RID OF CIGAR BOX CONFUSION!

HAVE THE RESISTOR YOU WANT
RIGHT AT YOUR FINGER TIPS



FREE!... THE IRC RESIST-O-CABINET

Here's an end to cigar boxes, tin cans, jars and other unsatisfactory make-shift methods of keeping resistors. The IRC Resist-O-Cabinet is specifically designed to hold resistors systematically and safely without bending of leads. It gives you a compact resistor "department" that puts any wanted resistor right at your finger tips and gives you a visual inventory of your resistor stock in a split second. Best of all . . . it's yours without one penny extra cost . . . with any of three factory-packed IRC Resistor assortments.

IRC Type BT Metallized have won acknowledged leadership in every mechanical and electrical characteristic. They're always dependable—they stay put. 1/2-, 1- and 2-watt sizes in all ranges. Insist on IRC's and be sure to get the FREE Resist-O-Cabinet! Your jobber has yours ready.

INTERNATIONAL RESISTANCE CO.

401 North Broad Street

Philadelphia, Pa.



INSULATED Metallized RESISTORS

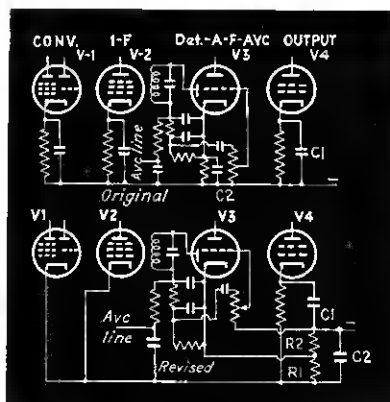

ers. This involves no more serious loss than a wider variation in tube gain from set to set of the same type.

In the revised circuit the resistance R1 and R2 are connected between the negative return and chassis and the cathode of tube V3 is connected to the junction. With no signal input the avc line will have the same potential to the chassis as V3 cathode and will be negative to chassis by the amount of the voltage drop across R1. This negative bias is decoupled in the usual way, and fed to the grids of V1 and V2, making the cathode bias unnecessary. The ground end of the volume control is returned to the negative side of R2 and the voltage across this resistance provides the bias for B3. The

plate current of V4 passes through R1 and R2, and it is therefore necessary to arrange the 50 mfd condensers C1 and C2 so that the audio frequency voltage built up across R1 and R2 from the a-f components of the plate current of V4 shall be a minimum, and so produce a negligible amount of feed-back into the grid and cathode circuit of tube V3.

Nine Bounces for Electrons

An electron multiplier is a vacuum tube which utilizes the phenomenon of secondary emission to amplify signals composed of electron streams.

In the multiplier phototube, shown in the circular schematic, the electrons emitted from the illuminated photocathode are directed by the fixed electrostatic fields along curved paths to the first dynode (secondary emitter). These electrons impinge on the dynode surface and produce many other electrons, the number depending on the energy of the impinging electron. These secondary electrons are then directed to a second dynode and knock out more new electrons.

This multiplying process is repeated in each successive stage shown by the arrows in the diagram with an ever-increasing stream of electrons, until

those emitted from the last dynode (dynode No. 9) are collected by the anode and constitute the current utilized in the output circuit.

This principle is employed in the RCA-931, a new type of high-vacuum phototube in which the photocurrent produced at a light-sensitive cathode is multiplied many times by secondary emission occurring at successive dynodes within the tube. It is capable of multiplying feeble currents produced by weak illumination as much as 230,000 times. The resultant output current is a linear function of the exciting illumination under normal operating conditions. Since secondary emission occurs instantaneously, frequency response of the 931 is flat up to frequencies at which transit time becomes a limiting factor.

The 931 employs the S4 photo-surface which has much higher sensitivity

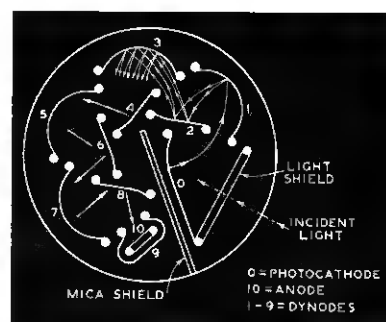

DON'T JUNK YOUR OLD RADIO TUBES

• You can cash them in for valuable merchandise under General Electric's New Radio Tube Merchandise Award Program.

Get the facts! Talk with your nearest G-E Radio Tube distributor or write the General Electric Company, Radio and Television Department, Bridgeport, Conn.

GENERAL ELECTRIC

NEVER "STATIC"...ALWAYS MOVING!

We're always ready to move fast, carrying your shipments, coming or going, at passenger-train speed between 23,000 nation-wide points. Trained employes carefully handle shipments all the way, whether radios, tubes, accessories or a new window display from the manufacturer. Pick-up and delivery without extra charge within our regular vehicle limits in all cities and principal towns. Economical rates.

—And—
When you want 3-mile-a-minute speed, specify **AIR EXPRESS**.

RAILWAY EXPRESS
AGENCY INC.

NATION-WIDE RAIL-AIR SERVICE

If he sells

RADIO

and other modern home equipment, he's the
LIVEST DEALER IN TOWN!

And **RADIO RETAILING** is
his preferred trade paper

WESTMINSTER and HOUR CHIMES

Quick Profit Outlet for Your Sound Department

Two important reasons why Westminster and Hour Chime Systems offer a quick profit outlet are: first, more and more churches, public and semi-public buildings, office buildings and manufacturing plants, are installing them; and second, installations usually sell for more than the average sound installation; hence, you make a greater profit.

Sunco Chime Systems automatically play either the Westminster or Canterbury Chimes, or the Angelus. Complete systems playing only hour chimes can also be furnished. Sunco Chime Systems are installed and serviced by qualified sound men exclusively.

You will find many exclusive features, fine and correct engineering, unequalled tone quality, sales help and leads to insure selling success. Why not let Sunco Chime Systems make this your biggest money-making year?

We have a real profit-making proposition for well rated sound organizations.

SUNDT ENGINEERING CO.

Manufacturers of
SUNCO CHIME CARILLONS
& CHIME SYSTEM

4791 N. Ravenswood Ave., Chicago, Illinois

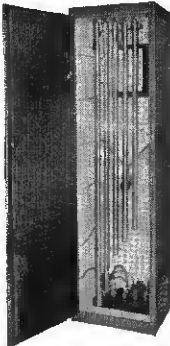

Sunco Westminster Chime Cabinet ready for installation and wiring to speaker in the tower.

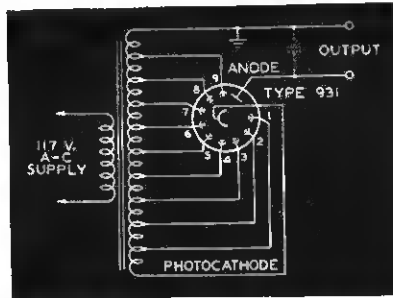

to blue-rich light, such as that from a mercury-vapor lamp. Its sensitivity to incandescent light depends on the color temperature of the source.

The voltage applied to consecutive stages of the 931 increases in equal steps from the photo-cathode to the 9th stage. The voltage between dynode No. 9 and anode is not critical but should be kept as low as will permit of current saturation.

A typical circuit for use of this tube with an a-c power supply is also shown. A uniformly tapped transformer is used in this circuit but convenient control of the amplification of the 931 may be obtained at a slight sacrifice of sensitivity through defocusing the electron paths by making the voltage step of one dynode unequal to that of the others.

Since the tube has about equal sensitivity for a-c and d-c voltages having the same rms value this circuit is suitable for relay operation.

Here is the BIG OPPORTUNITY OF 1941 KNOCKING AT YOUR DOOR!



Never have you had a greater value to offer your customers—or a product so easy to sell—as the new

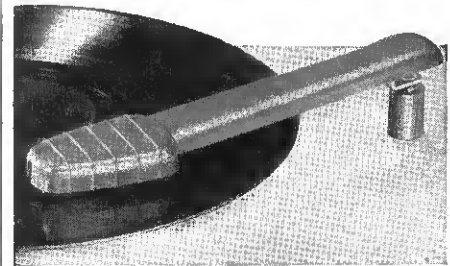

Webster Electric AJ1 Crystal Pick-Up

for Modernizing
Tone Reproduction

This new Pick-Up completely revolutionizes the tone reproducing quality of record players and combinations . . . a streamlined bakelite tone arm with precise balance, light weight, and only 40 grams controlled pressure on a new long life needle! The AJ1 Pick-Up will vastly improve the reproducing quality of your customers' present equipment.

Here is a BIG VALUE that all of your customers can afford . . . priced so low they will jump at the chance to buy it when you explain the improved tone quality, freedom from surface noise and longer record life they can get at such low cost by using a Webster Electric AJ1 Pick-Up.

Display it in your store—show and demonstrate it on your service calls—order today and start cashing in without delay.

(Licensed under patents of the Brush Development Company)

WEBSTER ELECTRIC COMPANY
Racine, Wis., U. S. A. Established 1909
Export Dept.: 100 Varick St., New York City. Cable Address: "ARLAB", New York City



WEBSTER ELECTRIC

"Where Quality is a Responsibility
and Fair Dealing an Obligation"

BIG BOY

MODEL
860

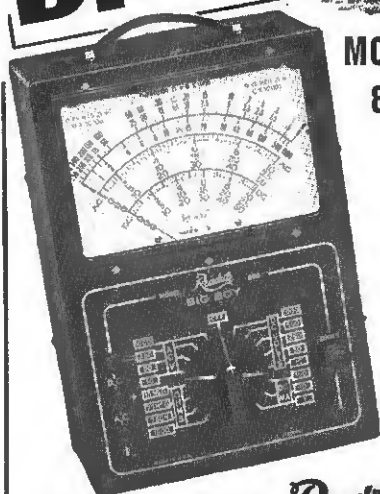

Performance . . . Eye Appeal . . . Value . . . Sensationally Priced at \$19.65. Dealer Net Price.

Readrite
METER WORKS

Here is an AC-DC Volt-Ohm-Milliammeter with all the ranges you want . . . easily readable on the large 7" instrument with extra-long 6" scale, in a new up-to-the-minute three-tone case. DC Volts 0-10-50-250-500-1000 at 5000 Ohms per volt DC; 1000 ohms per volt AC. AC Volts 0-10-50-250-1000 at 400 ohms per volt; DC Ma. 0-1-10-100; Resistance ranges: 0-1500 Low Ohms; 0-150,000 Ohms and 0-7.5 and 0-15 Megohms. Maroon case with red and silver panel, attached handle.

Dealer Net Price, \$19.65

For Catalog Write—Section 207, College Drive

READRITE METER WORKS, Bluffton, Ohio

Audio Frequency

BLINKING AC-DC RECEIVERS are usually caused by a defective heater in one of the tubes. Since the heaters are in series and check through when cold it is often hard to tell just which tube is causing the blinking condition.

One way of finding out quickly is to connect one tube at a time in series with an ordinary house bulb connected to the power line.

A test lead setup can then be used for testing the tubes in their sockets or sockets may be mounted on a breadboard and the heater terminals wired in parallel to one another and in series with the test bulb and line.

A 30 or 40 watt lamp will take care of tubes drawing .3 ampere but use a 15 watt for tubes drawing .15 amp., 60 watt for .6 amp. heaters.

Since the tube under test and the lamp are receiving almost normal voltage the lamp will light if the tube is good. Heaters that are partially or entirely open only after reaching operating temperature will let the lamp go out after heating.

If heavier current types need similar testing use a 75 watt lamp for .7 amp. heaters, 100 watt for .9 amp. and 150 watt for 1 to 1.5 amp. tubes.

ATLAS SOUND SENSATION!

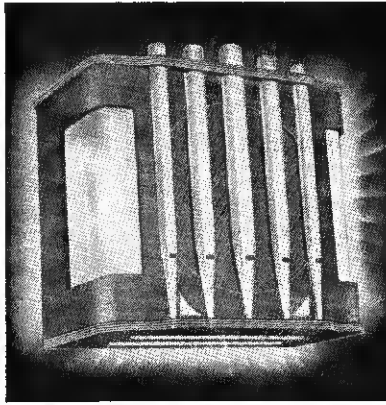

**ILLUMINATED
"ORGANETTE"
ACOUSTIC SPEAKER ENCLOSURE**

★Add Glamor to P. A. Installations . . . Try the new Illuminated "ORGANETTE" Cabinet on your next night club, tavern, or restaurant job. The "ORGANETTE" is made of natural walnut veneers, mandarin red plastic, gold-lacquered "pipes", and acousti-cloth grille. Distinctive lighting from front, sides, and bottom of cabinet. Wiring, bulbs, plug, and line cord supplied . . . JUST PLUG IN TO LIGHT UP. For All 12" Speakers. 17" x 15" x 8".

MODEL OR-12 LIST PRICE \$15.00

FREE: NEW CATALOG F-41, AND COLORFUL WINDOW DISPLAY



★ Write Dept. RR-7 NOW!
ATLAS SOUND CORPORATION
1445 39th St., Brooklyn, N. Y.

**THE EASY WAY TO
CUT HOLES
IN
RADIO
CHASSIS**



Here's a handy tool to help the radio worker save many hours of work when cutting holes for sockets, plugs, connectors, and meter holes in radio chassis. No tedious drilling, reaming, or filing is necessary. A cap screw is inserted in a small drilled hole, and the punch is easily forced into the die by a few turns of the cap screw with an ordinary wrench. Ten punches are available for cutting $\frac{3}{4}$, $\frac{7}{8}$, 1, $1\frac{1}{8}$, $1\frac{1}{2}$, $1\frac{3}{8}$, $1\frac{1}{4}$, $1\frac{3}{8}$, $1\frac{1}{2}$ and $2\frac{1}{4}$ -inch holes. Write for more information.

GREENLEE TOOL CO.
1708 Columbia Ave., Rockford, Ill.

GREENLEE TOOL CO.
1708 Columbia Ave., Rockford, Ill.
Please Send Information On Greenlee Radio Punches.

NAME.....
ADDRESS.....
CITY..... STATE.....

Servicing HIGH FIDELITY Receivers

HOW TO FIX common troubles
of the higher priced models

By CHARLES SEEGER and GEORGE BECK

IN SPITE of their initial cost a surprising number of high fidelity receivers have been sold.

Owners of these sets are almost invariably willing to spend more money than the average customer for service, although at the same time they are more critical.

Because of this and the fact that we have spent more than three years in servicing such receivers we feel that our experience may be of value to other servicemen when they encounter these models.

Due to the high audio response of this type of set certain kinds of noises and crackling sounds are more noticeable to the ear than they would be in receivers having a more limited audio range. Owners of the latter are often inclined to overlook an occasional crackle that might originate in the set, may even subdue it by use of the tone control and perhaps conclude that the noise is a natural condition that must be endured.

Anticipate Noise Troubles

The discriminating listener who likes the high audio frequencies is, on

the other hand, always conscious of any sounds that interfere with his reception and care must be taken to eliminate all possible causes of noise at the time of repair. With controls set for the highest a-f response the chassis and parts may be tapped and moved while listening to the result from the speaker. Loose connections will quickly be found during this operation and in addition careful servicemen will frequently encounter worn threads of low frequency padding screws, worn i-f trimmer screws and loose shield caps and r-f coil cans.

Where shielded leads are employed it is best to completely insulate the shielding from the chassis with rubber tape at points where it is not directly grounded. Many mystifying noises can develop between shielding and the chassis even though the ends of the shielding are soldered to the chassis. This also applies to ground bonds, they should clear the chassis and parts so that they are in contact with the chassis only at their grounded ends.

Some models have a monkey chatter filter consisting of a large, air-wound coil and a .003 mfd condenser connected in series from plate to plate

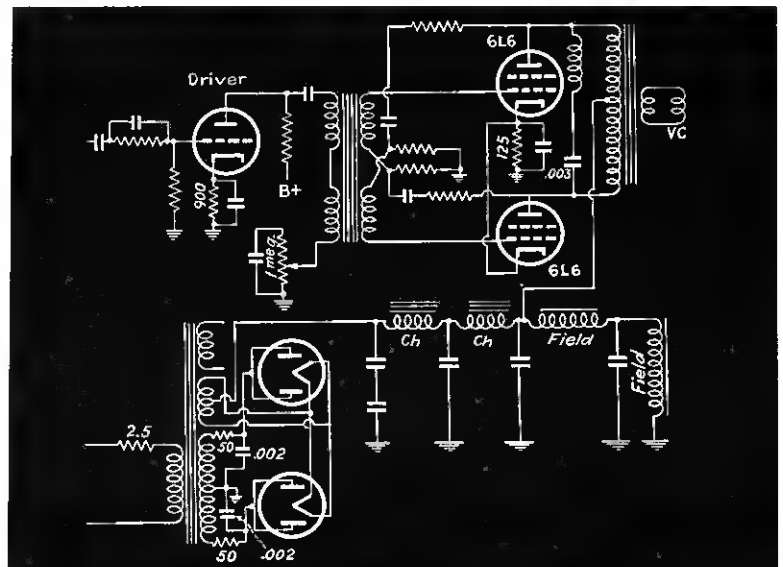

CIRCUIT of a typical power supply and amplifier stages employed in many high fidelity chassis

*Service Men
have bought
Over*
**100,000
SUPREME Testers**

Could there be more convincing proof of SUPREME quality, accuracy, dependability and fair price than the fact that servicemen who know their test equipment have invested over \$5,000,000.00 in over 100,000 SUPREME testers?

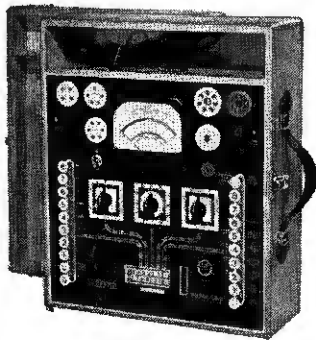

MODEL 504-A
TUBE AND SET TESTER

Our experience has equipped us to put even more value in the second 100,000 SUPREME instruments than in the first. Write Dept. RR-6 for full information on 1942's TOP line of testing equipment.

SUPREME

GREENWOOD, MISSISSIPPI, U. S. A.

AUGUST

What should dealers do to maintain Profits during the Emergency?

More timely articles giving logical solutions to this perplexing question—such as "3 Paths to Profit" will appear in the August Issue of RADIO and Television RETAILING.

of the 6L6G output tubes. Other sets may include a resistor in place of the coil. This filter may be located in the chassis or in the base or mounting of the speaker. Complaints of very weak, distorted reception with the volume control on full are usually due to the .003 mfd condenser shorting. Since the peak audio voltage that occurs in the plate circuit of the push-pull tubes is about 1,000 volts replacement can be made with two .006 mfd 600 volt units in series.

Peak Voltage Breakdowns

It might be well to mention that the volume control should not be turned to maximum when no signal is being received and test leads are being used. Sets of this type usually have from twenty to forty watts of audio power and one good noise thump will knock the speakers galley-west, even if they are partially baffled on the bench.

These sets usually use a fairly high plate voltage, often being over 400 volts from plate to cathode of the power tubes at a line voltage of 115 volts. Higher line voltage than this seriously impairs the life of the power tubes and the filter condensers. Use the best grades of condensers and when replacing them be sure they cannot touch the filter chokes or they will buzz and tend to overheat.

Where it has seemed advisable because of high line voltage or other reasons we have found a cure-all by inserting a 2.5 ohm fifty watt resistor in series with the primary of the power transformer. (The larger sets draw about three amperes primary current and if the resistor is mounted under the chassis it gets very little ventilation.)

Complaints of 'buzzy cracks', hum and frying noise at low volume may be due to internal breakdown of the power tubes. To check allow the receiver to heat for five minutes, turn volume control low and impact tubes. Noises of this type may take some time to develop.

Occasionally a set will be encountered that employs rubber grommets under the filter chokes. To cure a loud mechanical buzz from chokes so mounted remove the rubber grommets and mount the chokes directly on the chassis or power pack. Use rubber feet under the pack itself.

The frames of the chokes are not usually grounded and a small leakage to the winding is not uncommon. Be careful when handling them with the current on or you will find yourself waving the power pack at Saint Peter.

R-F and I-F Stages

Almost without exception we have found it best not to touch the i-f ad-

RECOTON

phoneneedles

STAR FEATURED
NATIONAL ADVERTISING



★IN THESE MAGAZINES★



Our large scale national advertising in these well known publications will send business your way. Cash in on the easy sales of these star-endorsed needles.

The finest and most popular needles for recording and playback

Recognized for their superior quality . . . the choice of professionals and all music lovers . . .

Endorsed by such famous stars as

JIMMIE DORSEY BOB EBERLY
HELEN O'CONNELL CONNIE BOSWELL

RECOTON playback needles make your records sound better.

RECOTON cutting needles are made of the finest material and are fabricated with the precision of fine watch parts.

Ask for our literature and displays

Fast Repeats — Fast Turnovers — Fast Profits

RECOTON CORPORATION

42 West 15th St.

N. Y. C.

**BRACH
Antennae**

Automobile
Home — All types
F-M Systems
Television
Police • Marine
Multiple Systems
Complete Kits
Accessories

Made by World's Oldest and Largest
Manufacturers of Radio Aerial Systems

L. S. BRACH MFG. CORP.
55 DICKERSON STREET
NEWARK, N. J.

justments without observing the results on an oscilloscope. Due to the use of complex, multi-channel i-f systems, over coupled transformers, and the not uncommon presence of unwanted regeneration, it is practically impossible to properly align the i-f amplifier without the 'scope and a frequency modulated oscillator.

When a set distorts on local stations a common cause is a shorted r-f trimmer. They are usually easily located by turning each trimmer a few turns clockwise and noting if the distortion clears. If a defective trimmer is found it is best to replace it as a momentary clearing by blasting or tuning is seldom permanent.

When the short wave calibration and tracking are off around the 10 to 12 megacycle band and the oscillator coil is shielded remove the shield can and check the tracking. If the dial then tracks fairly well move the end turn of the oscillator coil inward and replace the shield can. Increasing the inductance in this way compensates for the lowered inductance caused by the shield.

On some high fidelity models the panels are bakelite or other material and scratches cannot be removed in the same manner as on wooden panels. For this reason it is best, when replacing controls, to mount any index plates with strips of scotch tape.

TRICKS of the TRADE

THREE-WAY PORTABLES

Distortion or low gain on ac . . . check filament voltage. If above or below normal the series filament voltage dropping resistor has changed value.

CAPEHART 400

Chatter from motor when changing records . . . take down motor, clean and oil thoroughly, put grease on gears and shaft seat and install one or two thin armature shims.

EMERSON DM 331

Dead on broadcast band, ok on short waves . . . check oscillator coil for open in broadcast section of windings.

FORD 1940 (Philco F-1740)

Intermittent operation . . . replace cathode resistor in 7A7 i-f stage with 700 ohm $\frac{1}{2}$ watt resistor.

G-E Handyphone

Substation indicator slips to wrong stations . . . remove copper spring from indicator bushing and drill and

tap bushing for set screw. Replace chassis in cabinet without indicator and mount indicator on shaft from front of cabinet.

G-E GD-60

Noisy . . . replace filter with 40 mfd condenser from rectifier cathode to switch, and 16 mfd from screen to cathode of 25L6G.

GRUNOW 12B

Microphonic when cabinet is jarred and on high volume . . . check rivet at ground end of output stage bias resistor. Solder lug to chassis and eliminate rivet from circuit.

PHILCO 20

Hum . . . if changing filters does not help add an 8 mfd electrolytic condenser across r-f bypass unit no. 3615-K. Try both terminals, outside positive lug usually best.

PHILCO 89

Intermittent . . . check second i-f transformer for high resistance caused by corrosion.

RCA M-34

Oscillation and intermittent recep-

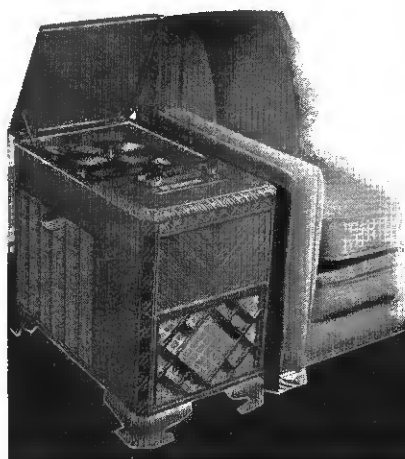

It's New -- It's Here to Stay -- the HOWARD Automatic Record Changing Arm-Chair Radio

Again Howard cracks a new market with an unbeatable sales and profit opportunity — the new "Arm Chair Radio."

Each beautiful cabinet, available in 3 finishes, contains the famous 8 tube, 2 band Howard chassis providing over 7 watts of powerful push-pull output; 12 inch Jensen electrodynamic speaker, automatic volume control, push-button tuning, electric eye and built-in loop antenna — plus convenient storage compartment for record albums.

In combination with this superb set-up is the latest type automatic record changer. Plays 10 records automatically and has high fidelity crystal pick-up assuring the full rich reproduction synonymous with the famous Howard name.

The many exclusive Howard features of higher priced units are "wrapped up" in this choice "bundle" of radio value. Write today for extra profits tomorrow!

HOWARD RADIO COMPANY

1731-35 Belmont Av., Chicago, Ill. - Cable Address: HOWARDCO, USA

America's Oldest Radio Manufacturer

You bet. We're in step with progress — with better listening, and therefore with quicker sales and more sales. Take us on, you wide-awake dealers.

Ken-Rad Tube & Lamp Corporation
Owensboro,
Kentucky

DEPENDABLE
Radio Tubes

KEN-RAD



TUNE IN ON SPEED!

You may be a retailer, a wholesaler, distributor or in the service trade—but whatever your field, RAILWAY EXPRESS is ready to help you by supplying swift, sure and economical service for anything you have to send or receive. There's no extra charge for pick-up and delivery within our regular vehicle limits in all cities and principal towns. Insurance up to \$50 per shipment also included. A phone call brings service.

RAILWAY EXPRESS
AGENCY INC.

NATION - WIDE RAIL - AIR SERVICE

tion . . . replace the 3.6 mfd screen grid bypass. This unit is contained in the double section unit in back of the tuning condensers underneath the chassis.

RCA 98-K

Fades . . . the .05 mfd avc filter condenser, C9 in schematic, partially opens.

RCA QU5

Dead on spread-band tuning, ok on A and B bands . . . check air trimmer, C2 in schematic, connected from bandswitch to ground, for short.

RCA U-46

Dead . . . check voltage divider unit for ground to case.

RCA QU5

Poor tone . . . connect a dry cell across voice coils, cones should move in same direction. If they do not, reverse voice coil leads to one speaker.

RCA Q44

Weak . . . mica condensers in can of third i-f transformer touch each other and cause leakage between primary and secondary windings.

RCA V-300

Frying noise similar to electrical interference . . . internal leakage in three section filter no. 32240.

RCA Q33

Chokes up as volume control is advanced . . . check ten megohm grid resistor of the 6SQ7 tube for open.

RCA 94X2

Hum . . . reverse speaker voice coil leads.

RCA 46X12

Dead . . . check oscillator coil for open at terminals.

RCA V170

Squeals as volume is advanced . . . replace volume control.

RCA U123

Fades . . . check 15M ohm screen resistor for increase in resistance or partial open. Replace with 10 watt unit.

RCA 94X1

Oscillates when carrier is tuned in . . . dress lead from output trans-

University

National Defense Factories

NEED!!!

HIGH EFFICIENCY SOUND SYSTEMS

NOW!!! is the time to go after *Industrial Sound Systems* in *National Defense Industries*. Factory Management recognizes the need for call systems, etc., and are 100% receptive to sound.

Be certain you know the advantages of the whole **UNIVERSITY REFLEX** line before you submit your specifications. All speakers in the University High Efficiency Reflex Line are well suited for the critical requirements of National Defense installations.

Do not hesitate to call on us for technical help in these installations. Write direct to our engineering department.

UNIVERSITY LABORATORIES

195 Chrystie St.
N. Y. C.

A. C. CURRENT ANYWHERE !!
IN CARS . . . ON FARMS . . . IN D. C. DISTRICTS

WITH **ATR**
D.C.—A.C.

INVERTERS

Illustrating Types 6 and 12 Standard Radio and Industrial Inverters only.

ATR Inverters have a proven background for performance, reliability and high quality. Insist upon ATR Inverters—a quality product at a low price.

Available in capacities from 15 watts to 500 watts in more than 75 different types for every possible need—Radio, Phonograph, Television, Electrical Appliances, etc.

Write for Complete Literature Covering ATR Products

- Shaverpacks
- Low Power Inverters
- Radio Inverters
- Industrial Inverters
- Vibrator Packs
- Polarity Changers
- "A" Battery Eliminators
- Battery Chargers
- Rectifier Packs
- Special Supplies
- "A-B" Power Units
- Vibrators

AMERICAN TELEVISION & RADIO CO.
ST. PAUL, MINN., U. S. A.
Cable Address: "Likex", New York

Modern Design
IN PHONOGRAPH NEEDLES

Modern reproduction demands modern design in phonograph needles, that is why

Fidelitone

FLOATING POINT needles with their exclusive Floating Point action meet all the demands of modern record reproduction. When you sell a Fidelitone Floating Point needle you are selling an unexcelled value at a real profit margin. Ask your distributor today!

See the Fidelitone Floating Point display—Music Show Room 959, Hotel New Yorker, New York City, July 28th to August 1st.

PERMO PRODUCTS CORP.
6415 RAVENSWOOD AVE.
CHICAGO, ILL.

Fidelitone
FLOATING POINT
Fifties Record Scratch
A NEW LONG-LIFE PHONOGRAPH NEEDLE

Manufacturing Metallurgists

AUTO-RADIO

at its Best



• That choice of types precisely fitted to different phases of the noise-suppression job, is provided by more than a dozen and a half different Aerovox types. Also the necessary choice of capacities and voltages. And each unit is designed and built for the severe-service conditions of the auto-radio installation. • Ask your jobber for latest catalog, and check over our auto-radio condenser line. Or write us direct for a copy.



BUT WHAT OF Tomorrow?

"All-out" production to meet today's pyramiding orders does not mean that Triplet has lost sight of the broader requirements of tomorrow. Instead, research and engineering programs actually have been "stepped-up" to assure constant improvements in products and processes; in addition to needed developments in new fields.

Today's demands are important, but the needs of tomorrow cannot be slighted—and are anticipated in never flagging engineering and research developments. You have assurance that in the months and years to come, new Triplet products will serve in expanded fields, where they will merit values and savings for every dollar spent in their purchase.

THE TRIPLET ELECTRICAL INSTRUMENT CO.
Bluffton, Ohio



former to plate of 25L6G away from 6J7 tube.

RCA V-205

Hum, not due to filters . . . reverse connections to voice coil hum-buck coil.

SIMPSON 320 Giant V.O.M.

Pilot bulb short life . . . insert six ohm one watt resistor in series with bulbs. Voltage drop is two volts using S-47 6-8 volt bayonet lamps.

ZENITH 6D-116

Dead, voltages normal . . . examine .02 mfd condenser connected to high end of volume control. Operation of control tends to pull lead of condenser. Replace condenser with more slack on leads.

MORE NEW MODELS

(Continued from page 16)

1942 so far comprises three models. All have tilt-front tuning, built-in loop antenna, and are equipped with "Uni-control Insta-Matic" record changer. Models A111 and 112 use 10 tubes while the A114 makes use of 11 tubes.

"Phono-Glide"

Westinghouse has 10 brand-new items: A Personal 3-way radio, at \$22.95, with beam power output and a 3½-inch P.M. speaker. And nine wood table models from \$18.95 to \$54.95. Included in this series is the WR290, a triple-band unit with frequency range from 540 kc to 18 mc. WR42X2 is an automatic phono-radio table model using 6 tubes.

Zenith's "advance" line includes forty sets ranging from \$12.95 for a plastic compact to \$129.95 for a low-boy type combination. Company plans to introduce higher-price styles in early July. "Consol-Tone" circuit is keynote refinement in table models, according to distributors who have already shown them to dealers. Other refinements include new large dial and improved "Radiorgan" tone color device. Prominent on several of the new combinations is the automatic "phono-glide." Pressing a button causes the mechanism to glide out where it is easily accessible for record loading.

INDEX TO ADVERTISERS

July, 1941

	Page
Aerovox Corp.	52
American Television & Radio Corp.	51
Ansley Radio Corp.	38
Atlas Sound Corp.	48
Belden Mfg. Co.	37
Brach Mfg. Co., L. S.	49
Burgess Battery Co.	32
Continental Radio & Telev. Corp.	17
Crosley Corp.	10
Dumont Labs., Inc., Allen B.	33
Electronic Laboratories, Inc.	36
Erwood Sound Equipment Co.	44
Farnsworth Television and Radio Corp.	4, 5
General Electric Co.	8, 9, 46
Greenlee Tool Co.	48
Howard Radio Co.	50
International Resistance Corp.	45
Ken-Rad Tube & Lamp Corp.	50
Mallory & Co., Inc., P. R.	Inside Front Cover
National Carbon Co., Inc.	Back Cover
Permo Products Corp.	51
Philco Radio & Telev. Corp.	23
Pioneer Gen-E-Motor Corp.	44
Presto Recording Corp.	32
Radio Corp. of America.	29
Railway Express Agency.	46, 50
Raytheon Production Corp.	7
RCA Manufacturing Co., Inc.	26, 27
Readrite Meter Works.	47
Recoton Corp.	49
Stromberg-Carlson Tel. Mfg. Co.	2, 3
Sundt Engineering Co.	47
Supreme Instruments Corp.	49
Triplet Electrical Instrument Co.	52
Turner Co., The.	39
University Laboratories.	51
Utah Radio Products Co.	6
Webster Electric Co.	47
Westinghouse Electric Supply Corp.	Inside Back Cover
Willard Storage Battery Co.	41

Although Radio & Television Retailing takes every precaution to insure accuracy, we cannot assume responsibility for an occasional change or omission in the above index.

McGraw-Hill Publishing Company, Inc. Publication Office: 99-129 North Broadway, Albany, N. Y. Editorial and Executive Offices: 330 West 42nd Street, New York, N. Y.



5 MORE CHALLENGES TO BETTER BUYMANSHIP

These 5 new Westinghouse Radios, typical of the whole line, have all the visible and hidden features which satisfy the most critical buyer. What your customer sees is beauty of design, harmonious woods, colorful dials and other eye-filling details. What he hears is fidelity of tone.

What he does not see or hear is the source of performance, the years of research, the sound engineering, the details of craftsmanship which combine to make an enduring musical instrument.

A set bearing the Westinghouse name—"the pioneer name in radio"—is a credit to you and its maker, in any home; it will perform in such fashion as to keep your customer satisfied and bring him back to you when he needs other Electrical Merchandise. That kind of customer relationship means permanence and profits to your business.

Write or phone your Westinghouse distributor today.



WESTINGHOUSE

WR-42X3. Beautiful Phono-Radio Console with improved Automatic Record Changer. 6-tube Superheterodyne, AC. Standard and Foreign Spread Bands. Automatic Volume Control. 12" Dustproof Dynamic Speaker. Inclosed Loop Antenna. Long Life Sapphire Needle in Crystal Pickup.



WESTINGHOUSE

WR-42X4. 18th Century Period, Walnut Low-boy Console. Phono-Radio with Improved Record Changer. 8-tube Superheterodyne, AC. Standard and Foreign Spread Bands. Automatic Volume Control. 12" Dustproof Dynamic Speaker. Rotating Inclosed Loop Antenna. Long Life Sapphire Needle in Crystal Pickup.

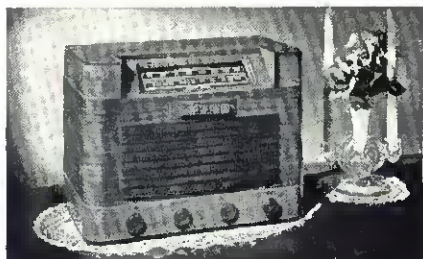

WESTINGHOUSE

WR-12X16. 8-tube Superheterodyne, AC-DC. Standard and Foreign Spread Bands. 5 Push Buttons. Automatic Volume Control. Elliptical Dustproof Speaker.



WESTINGHOUSE

WR-12X3. 5-tube Superheterodyne, AC-DC. Automatic Volume Control. Vernier Tuning. Dustproof Electro Dynamic Speaker. Inclosed Loop Antenna.

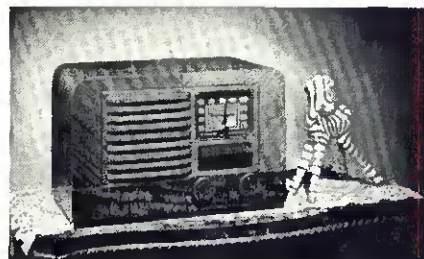

WESTINGHOUSE

WR-12X4. 5-tube Superheterodyne, AC-DC. 5 Push Buttons. Automatic Volume Control. Dustproof Dynamic Speaker. Inclosed Loop Antenna.

Westinghouse Precision **RADIO**

Here's why this "B" battery for portables
OUTSELLS ALL OTHERS COMBINED!



1. "Eveready" "Mini-Max" Radio "B" Battery No. 482 fits practically all makes of the portable sets now in use!
2. It lasts approximately twice as long (size for size) as batteries of ordinary round-cell design!
3. It costs no more than ordinary batteries for portable sets!

Here's the battery for "personal" or "camera-type" radios!

"Eveready" "Mini-Max" Radio "B" Battery No. 467 is the battery around which "personal" or "camera-type" portables were designed. 67½ volts in a space 3 5/8" x 2 11/16" x 1 5/16". More and more customers will ask for it.



"EVEREADY"
"MINI-MAX"

RADIO "B" BATTERIES

NATIONAL CARBON COMPANY, INC.

Unit of Union Carbide and Carbon Corporation



The words "Eveready" and "Mini-Max" are registered trade-marks of National Carbon Company, Inc.

FILL OUT AND MAIL COUPON NOW!

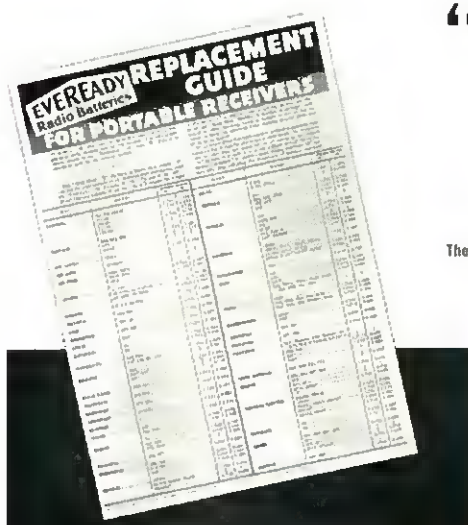

FREE! Replacement Guide for portable receivers! Tells the proper batteries for portable sets. Accurate! Up to the minute! Fill out and mail coupon at right for your free guide.

NATIONAL CARBON COMPANY, INC.
Department R,

Box 635, New York, N. Y.

GENTLEMEN:

Please send me FREE Replacement Guide.

NAME _____

STREET _____

CITY _____